

OPERATING INSTRUCTIONS FOR

PRECISION

MODEL 10-54

TUBE AND HIGH SENSITIVITY CIRCUIT TESTER



PRECISION APPARATUS COMPANY, INC.

70-31 84th STREET • GLENDALE 27, L. I., N. Y.

EXPORT DIVISION: 458 BROADWAY, NEW YORK CITY, U. S. A. CABLES: MORHANEX
CANADIAN SALES DIVISION: ATLAS RADIO CORP., LTD., 560 KING STREET W., TORONTO 28, ONTARIO

CONDENSED TUBE TESTING INSTRUCTIONS
(Series 10-12, 10-15, 10-20, 10-22 and 10-54 TUBE AND TEST MASTERS)

CAUTION: READ THE COMPLETE INSTRUCTION MANUAL BEFORE ATTEMPTING TO OPERATE THIS INSTRUMENT! USE THESE CONDENSED INSTRUCTIONS ONLY AS A SIMPLIFIED GUIDE FOR TEST OF STANDARD TYPE TUBES.

1. Depress "OFF" Button and connect attachment plug to 110-125 volts, 50-60 cycle source.
2. Set Controls "A", "B", "C", "D" and "E" to positions listed on roller chart.
3. **RETURN ALL LEVERS TO "NORMAL" POSITION** by use of the "Lever Return" mechanism.
4. Release "OFF" button by depressing "READ METER" button.
5. Rotate "LINE ADJUSTMENT" control until meter pointer lines up with "LINE" indication.
6. Insert tube to be tested and ALLOW TO HEAT.
7. Re-adjust "LINE ADJUSTMENT" control and throw "TUBE-COND." switch to "TUBE" position.
8. Perform SHORT/LEAKAGE TESTS by depressing buttons 1 through 12, watching the neon lamp as each button is depressed. If neon bulb glows as any one or more buttons are depressed (WITH THE EXCEPTION OF BUTTONS LISTED UNDER "FIL.CONT.", or those buttons listed as special roll chart notations), the tube should be discarded as defective.

NOTE - ALL LEVERS MUST BE IN "NORMAL" POSITION BEFORE AND DURING "SHORT/LEAKAGE TESTS!"

9. If short circuits have not been indicated, and neon glow has been obtained on those buttons listed under "FIL.CONT." (and those buttons specifically noted on the roller chart), THEN throw those levers to the positions indicated on the roller chart under headings W-X-Y-Z.
10. Depress the "READ METER" button and observe the tube Quality meter reading.

* * * * *
* * * * *

NOTE: Should any question arise concerning the operation, functioning or use of this tester, FIRST consult the related section of your INSTRUCTION MANUAL (including the "Service" Section). If the problem is not answered by the instruction manual, include COMPLETE DETAILS of the problem in your correspondence to the factory. THE MORE EXPLICIT THE DETAILS, THE MORE RAPIDLY AND SATISFACTORILY YOUR PROBLEM CAN BE ANALYZED AND ANSWERED!



PRECISION APPARATUS COMPANY, INC.
70-31 84th STREET . GLENDALE 27, L. I., N. Y.
Export Division 450 BROADWAY NEW YORK CITY, U. S. A. • Cables: MORHAMEX

CONTENTS

SECTION	PAGE NO.
A. Introduction and Summary of Tube and AC-DC Circuit Testing Features	1-2
B. Functions and description of controls, switches, levers, etc., incorporated on the panel of THE ELECTRONAMIC TEST MASTER	2
C. Operating instructions, (Vacuum tube testing)	5
Filament Continuity, Hot-Cathode Leakage and Inter-element short tests.	5
Audible Noise Test	6
Tube Quality Indication	6
Special Roller Chart Notations	
Eye tests (electron ray type indicator tubes)	6
FM/AM eye tube tests	7
Special Rectifier tests	7
Special Short indications notes	7
Gas type rectifier note	8
Multi-Section Tube Tests	8
Sub-miniature Tube Tests	8
Tube Brand Variations.	8
Pilot Lamp Tests	9
D. Ballast Information	9
Ballast Testing	9
Ballast Resistor Code	9
Ballast Test Procedure	10
E. Qualitative Paper Condenser Tests	11
F. Battery Testing Instructions	11
G. Operating Instructions (AC-DC Circuit Testing Functions)	13
H. Service Data	18
I. General Notes and Information	20
J. Principles of "ELECTRONAMIC" Tube Testing	
K. "ELECTRONAMIC" Test-Master Series 10-54 circuit diagram	
L. Decibel Conversion Chart	
M. Index (alphabetical)	

A. INTRODUCTION

THE SERIES 10-54 "ELECTRONAMIC" TEST-MASTER IS A MODERN PUSH BUTTON, MASTER-LEVER TYPE OPERATED VACUUM TUBE AND BATTERY TESTER COMBINED WITH A PUSH-BUTTON OPERATED HIGH SENSITIVITY 20,000 OHMS PER VOLT MULTI-TEST SECTION FOR OBTAINING WIDE-RANGE MEASUREMENTS OF A.C. AND D.C. VOLTAGES, OHMS, DECIBELS AND CURRENT FOR MODERN ELECTRONIC ANALYSES.

THE ELECTRONAMIC MASTER TUBE TESTING CIRCUIT HAS BEEN DESIGNED BY PRECISION ENGINEERS TO INDICATE THE OVERALL PERFORMANCE MERIT OF A VACUUM TUBE IN ONLY ONE DIRECT METER READING. SEE "PRINCIPLES OF ELECTRONAMIC TUBE TESTING" WHICH DETAILS THIS "PRECISION" FEATURE, AT REAR OF MANUAL.

THE MASTER ELEMENT LEVER SELECTOR SYSTEM INCORPORATED IN ALL ELECTRONAMIC "TEST-MASTERS" PROVIDES THE ULTIMATE IN TESTING FLEXIBILITY AND POSITIVE INSURANCE AGAINST NON-OBSOLESCENCE. THE PRECISION "TEST-MASTER" INCORPORATES: 12 INDIVIDUAL ELEMENT SELECTION CIRCUITS, ALL LATEST TYPE TUBE SOCKETS, MASTER CONTROL SOCKET FOR TUBES YET TO BE DESIGNED, AND OTHER CAREFULLY ENGINEERED PRECISION FEATURES. THESE FARSIGHTED FEATURES GUARANTEE YEARS OF SUCCESSFUL AND TROUBLE-FREE VACUUM TUBE TESTING PERFORMANCE.

SUMMARY OF TUBE ANALYSING FEATURES:

1. A "PRECISION" DESIGNED AND ENGINEERED TESTING CIRCUIT; (THE "ELECTRONAMIC" CIRCUIT) WHICH INSTANTANEOUSLY SUBJECTS A TUBE TO WIDE RANGE OPERATING CONDITION, SIMULTANEOUS WITH THE APPLICATION OF INDIVIDUAL, PREDETERMINED ELEMENT VOLTAGES.
2. ACCOMMODATES ALL MODERN TUBE TYPES AND FILAMENT VOLTAGES FROM .75 TO 117 VOLTS. TESTS NOVAL BUTTON 9 PIN TUBES, 7 AND 8 PIN SUB-MINIATURE TYPES, HEARING AID AND POCKET RADIO TUBES, DOUBLE-CAP U.H.F. TYPES, LOCTALS, SINGLE-ENDED (TV AND FM AMPLIFIERS), REGULAR OCTALS (MG, G AND METALS), SPRAY-SHIELD AND GLASS TYPES, MINIATURE 7 PIN TYPES AND ACORN TUBES.
3. BUILT-IN MINIATURE 7 AND 9 PIN STRAIGHTENERS:- RUSTPROOF, LONG-LIVED, STAINLESS STEEL PIN STRAIGHTENERS PROVIDE MEANS FOR CONVENIENT AND RAPID ADJUSTMENT OF BENT BASE PINS. ASSURES LONGER TROUBLE-FREE LIFE FROM TUBE TEST SOCKETS AND BETTER CONTACT WHEN TUBES ARE RETURNED TO ORIGINAL APPARATUS SOCKETS.
4. QUALITATIVE TUBE MERIT READINGS DIRECTLY INDICATED ON A SINGLE THREE COLORED ENGLISH READING SCALE SUPPLEMENTED BY A LINEAR SCALE FOR TUBE MATCHING AND QUALITATIVE COMPARISON PURPOSES
5. DOUBLE WINDOW, BRASS GEAR-OPERATED ROLLER TUBE CHART.
6. DUAL FREE-POINT FILAMENT TERMINAL SELECTION LOCATES TERMINALS OF ALL FILAMENTS (SINGLE, DOUBLE, CENTER-TAPPED) REGARDLESS OF ROTATING PIN POSITION COMMON TO MANY MODERN F.M. AND TELEVISION TUBES.
7. VISIBLE FILAMENT CONTINUITY TESTS; RAPIDLY PERFORMED BY THE PRECISION NUMBERED, PUSH BUTTON SYSTEM; SHOWS UP OPEN FILAMENTS FOR ALL TYPES OF TUBES REGARDLESS OF FILAMENT BASE CONNECTIONS. IN ADDITION, THIS PRECISION FEATURE IMMEDIATELY REVEALS THE OPEN SECTION OF TAPPED FILAMENTS.
8. MASTER ELEMENT LEVER OPERATED SELECTOR SYSTEM; THIS HIGHLY IMPORTANT PRECISION FEATURE COMPLETELY ELIMINATED ALL POSSIBILITIES OF INFLEXIBILITY DUE TO UNUSUAL MULTIPLE TUBE BASING TERMINATIONS OF NEW TUBES AND TUBES YET TO BE DEVELOPED. MAXIMUM SPEED IN THE USE OF THE LEVER SYSTEM IS ACCOMPLISHED BY THE UNIQUE FOOL-PROOF MASTER LEVER RETURN MECHANISM WHICH ALLOWS FOR INSTANTANEOUS RETURN OF ALL LEVERS TO "NORMAL" POSITION BEFORE TESTING A TUBE. INDIVIDUAL TIME-CONSUMING RETURN OF EACH LEVER IS THEREBY COMPLETELY ELIMINATED. IN ADDITION, SIMPLIFIED TUBE ANALYSIS IS MADE POSSIBLE BY THE STANDARD ELEMENT NUMBERING SYSTEM EMPLOYED.
9. SPECIFIC INDIVIDUAL LOADS AND VOLTAGES (CONTROL GRID, SCREEN, PLATE, ETC.) APPLIED TO EACH RESPECTIVE ELEMENT OF TUBE UNDER TEST.
10. METER READS IN PLATE CIRCUIT ONLY. INDICATIONS, THEREFORE, ARE ENTIRELY DEPENDENT UPON CONTROL ACTION AND CONDITIONAL ALL INTERVENING ELEMENTS.
11. OPEN ELEMENTS: SHOWS UP TUBES WITH OPEN ELEMENTS. THE EXCLUSIVE "ELECTRONAMIC" TUBE MASTER TEST NECESSITATES ALL ELEMENTS INTACT FOR PROPER READING.
12. TESTS DIODES, TRIODES, RECTIFIERS, TETRODES, PENTODES, MULTI-PURPOSE TUBES, GASEOUS TYPES SUCH AS OY4, OZ3, AND OZ4 AND REMOTE CONTROL GASEOUS TYPES SUCH AS OA4 AND 2A4, REGARDLESS OF VARYING FILAMENTS OR OTHER ELEMENT POSITIONS.
13. MULTI-SECTION TUBES: INDIVIDUAL TESTS FOR EACH SECTION OF MULTI-SECTION TUBES INCLUDING VISIBLE TESTS OF THE FLUORESCENT SCREEN, WINKING EFFECT ON CATHODE RAY INDICATOR TUBES AND FM/AM ALIGNMENT RAY INDICATOR TUBES. NO SHIFTING OF TUBES IS NECESSARY TO OBTAIN ALL TESTS.
14. HOT CATHODE LEAKAGE TEST: SENSITIVE NEON METHOD QUICKLY SHOWS UP POOR CATHODE STRUCTURE IN ACCORD WITH LEAKAGE SPECIFICATIONS OF LEADING TUBE MANUFACTURERS.

15. DUAL SENSITIVITY HOT INTER-ELEMENT SHORT TESTS MADE INGENUOUSLY SIMPLE THROUGH THE USE OF PRECISION AUTOMATIC INTERLOCKING PUSH-BUTTONS, AND LENS-PROTECTED MAGNIFIED NEON LAMP. DOUBLE SENSITIVITY IS MADE AVAILABLE THROUGH THE FLIP OF A SWITCH TO PERMIT SPECIAL APPLICATION TUBE SELECTION TO MORE RIGID STANDARDS.

16. NOISE TEST PIN JACKS INCORPORATED FOR EARPHONE OR AMPLIFIER CONNECTION. EACH ELEMENT CAN BE SEPARATELY NOISE TESTED THROUGH USE OF FREE-POINT AUTOMATIC INTERLOCKING PUSH-BUTTON SYSTEM.

17. BALLAST TEST: THE REGULAR TUBE TEST SOCKETS ACCOMMODATE ALL BALLAST UNIT TESTS FOR OPEN AND LOOSE ELEMENTS AND LEAKAGE BETWEEN SECTIONS OF MULTI-SECTION BALLASTS; MADE POSSIBLE THROUGH THE PRECISION RAPID-ACTION PUSH-BUTTON SYSTEM.

18. PILOT LIGHT TESTS FOR ALL MINATURE SCREW BASE AND BAYONET TYPE LAMPS.

19. ACCURACY OF THE TUBE TEST CIRCUIT IS CLOSELY MAINTAINED BY THE USE OF INDIVIDUAL CALIBRATING CONTROLS, ADJUSTED AND SEALED AT THE FACTORY AGAINST LABORATORY STANDARDS AND THROUGH USE OF INDIVIDUAL, 1% BRIDGE-CALIBRATED WIRE WOUND SHUNTS.

20. LARGE, EASY-TO-READ, D'ARSONVAL, DOUBLE-JEWELLED PACE METER, ACCURATELY BALANCED AND FACTORY-CALIBRATED TO WITHIN ± 2 PERCENT.

21. TUBE SELECTION REFERENCES PLAINLY MARKED ON PANEL IN LARGE EASY-TO-READ CHARACTERS, ELIMINATING MEMORIZATION OR GUESSWORK.

22. PILOT LIGHT ON-OFF INDICATOR.

23. PANEL-MOUNTED FUSE EXTRACTOR POST.

24. MICRO-LINE ADJUSTMENT, READ DIRECTLY ON METER, PROVIDED BY USE OF CONTINUOUSLY VARIABLE, HEAVY DUTY LINE VOLTAGE CONTROL.

25. TELEPHONE-CABLED PLASTIC INSULATED WIRING EMPLOYED THROUGHOUT. CRITICAL CIRCUITS INDIVIDUALLY SHIELDED AND BY-PASSED FOR MOST ACCURATE TESTS OF VERY HIGH MUTUAL CONDUCTANCE T.V. AND F.M. AMPLIFIERS.

26. PAPER CONDENSER LEAKAGE TESTS. SENSITIVE NEON METHOD.

27. TEST CIRCUITS COMPLETELY ISOLATED FROM POWER LINE.

AC-DC CIRCUIT ANALYZING SUMMARY OF FEATURES
--

1. SIX A.C. VOLTAGE RANGES: 1000 OHMS PER VOLT
0-6 - 12 - 60 - 300 - 1200 - 6000 VOLTS
SIX D.C. VOLTAGE RANGES: 20,000 OHMS PER VOLT
0-6 - 12 - 60 - 300 - 1200 - 6000 VOLTS
2. SEVEN D.C. CURRENT RANGES:
0-60 - 120 MICROAMPERES
0-1.2 - 120 - 1200 MA AND 0-12 AMPERES
3. FOUR SELF CONTAINED RESISTANCE RANGES: (NO A.C. POWER REQUIRED).
0-6000 - 6000,000 OHMS; 0-6 - 60 MEGOHMS
4. SIX DECIBEL RANGES FROM -10 TO +77 DB.
5. SIX OUTPUT RANGES: SAME AS A.C. VOLTS.
6. 1% WIRE WOUND SHUNTS AND MATCHED METALIZED MULTIPLIERS.
7. ONLY 2 POLARIZED TIP JACKS SERVE ALL STANDARD RANGES.
8. AUTOMATIC INTERLOCKING PUSH-BUTTON RANGE SELECTION.
9. ALL CIRCUITS ISOLATED FROM POWER LINE.
10. LARGE EASY READING SCALES AND NUMERALS. A.C. AND DECIBEL SCALES DISTINCTIVELY IDENTIFIED IN RED.
11. ACCURACY OF ALL RANGES CLOSELY MAINTAINED THROUGH INDIVIDUAL CALIBRATION AND USE OF CONTROLS ADJUSTED AND SEALED AGAINST LABORATORY STANDARDS.

B. FUNCTIONS AND DESCRIPTION OF CONTROLS, SWITCHES AND LEVERS PROVIDED ON THE INSTRUMENT PANEL.

THE FOLLOWING IDENTIFICATIONS AND DESCRIPTIONS SHOULD BE CAREFULLY READ: FULL FAMILIARITY WITH THE CONTROL FUNCTIONS WILL GREATLY FACILITATE TESTING PROCEDURES:

CONTROL A - LOAD AND VOLTAGE SELECTOR. THIS SWITCH SELECTS ANY ONE OR A COMBINATION OF LOADS AND PLATE POTENTIALS APPLICABLE TO THE PARTICULAR TUBE UNDER TEST. IN ADDITION, CONTROL "A" PROVIDES FOR VARIATION OF THE BASIC METER SENSITIVITY, ALLOWING FOR STANDARDIZED TESTING OF DIODES, LOW CURRENT TYPES, AND OTHER SPECIAL VACUUM TUBES.

CONTROL "A" IS ALSO THE FUNCTION SELECTOR FOR ALL MULTI-TEST RANGES AND FOR DRY BATTERY TESTING.

CONTROL B - Filament Return Selector

Control B provides free-point filament terminal selection for all type tubes, regardless of filament base termination arrangement.

CONTROL C - Control-grid voltage potentiometer: provides selected test input circuit potentials which are automatically applied to the control grid selected by the MASTER LEVER SYSTEM. In addition, Control "C" functions as the OHMS ADJUST control for all resistance ranges.

CONTROL D - Meter sensitivity potentiometer; A special, tapered potentiometer enabling the setting of calibration limits for all tubes as noted on the tube test roller chart.

CONTROL E - FILAMENT VOLTAGE SELECTOR: PROVIDES A COMPLETE RANGE OF 18 FILAMENT OPERATING POTENTIALS FROM .75 THROUGH 117 VOLTS. CONTROL "E" ALSO FUNCTIONS AS DRY BATTERY TEST RANGE SELECTOR WHEN SWITCH "A" IS SET TO "BATTERY TEST" POSITION.

MASTER LEVER SWITCH (Master element selector)

This MASTER switch consists of 12 individual 5 position switches. Each switch is individually numbered from 1 through to 12. Each number represents a tube element number as listed by Tube Manufacturers and the Radio Manufacturers Association. For example, consider the case of a screen grid tube type 6SJ7. The tube element numbering, as listed in standard tube manuals, is as follows:

Pin 1 - No Connection
 Pin 2 - Heater
 Pin 3 - Suppressor
 Pin 4 - Control grid
 Pin 5 - Cathode
 Pin 6 - Screen grid
 Pin 7 - Heater
 Pin 8 - Plate

When a type 6SJ7 tube is inserted into its socket, pin 1 of the tube is automatically connected to Master lever 1; pin 2 to Master lever 2; pin 3 to Master lever 3; etc. (Each numbered lever, therefore, controls the application of its corresponding tube element into the appropriate tube tester circuit.) It will be noted that each Master lever can be thrown into any one of 5 positions, indicated as: W, X, Y, Z and "Normal". The normal purposes of these positions are listed as follows:

Position "W" - Open position. Any lever thrown to the "W" position open-circuits its corresponding tube element.

Position "X" - Screen Grid position. In the case of the 6SJ7, element 6 is screen grid. Lever 6 therefore, becomes the screen lever, and this lever is thrown to position "X".

Position "Y" - Plate circuit position. Element 8 of type 6SJ7 is a plate. Lever 8, therefore, becomes the plate lever and this lever is thrown to "Y" position.

Position "Z" - Grid circuit position. Element 4 of 6SJ7 is control grid. Lever 4, therefore, becomes the grid lever and this lever is thrown to "Z" position.

Position "Normal" - Common termination to cathode and/or reference potential.

All elements requiring a "Normal" or cathode potential level such as Suppressor grids, cathodes, etc. are accordingly accommodated by leaving the corresponding levers in "Normal" position.

It is therefore seen that the complete lever setting for type 6SJ7 tube is simply set up as follows:

W	X	Y	Z
-	6	8	4

Only 3 levers in this example require actuation. All other levers are untouched and are left in the "NORMAL" position.

Although the connecting network of the MASTER LEVER SELECTOR appears complicated behind the instrument panel, its operation from the top of the panel is unusually simple and straight-forward!

THE LINE ADJUSTMENT CONTROL

This control permits adjustment for the operating line voltage when the meter pointer is brought to the arrow-head center of the scale plate marked "LINE". This control is a heavy duty, continuously variable, wire wound potentiometer, assuring step-free, positive, micro-voltage adjustment.

THE PUSH BUTTON SYSTEM:

1. BUTTONS 1 THROUGH 12. THESE BUTTONS, IN CONJUNCTION WITH THE DUAL SENSITIVITY NEON TEST CIRCUIT, PERMIT RAPID SHORT AND LEAKAGE CHECK OF ALL TUBE ELEMENTS, MERELY BY CONSECUTIVELY DEPRESSING BUTTONS 1 THROUGH 12 AND OBSERVING THE NEON LAMP INDICATIONS. VISIBLE FILAMENT CONTINUITY TESTS ARE ALSO PROVIDED BY THE PUSH BUTTON SYSTEM IN CONJUNCTION WITH DATA LISTED UNDER "FIL. CONT." ON THE ROLLER CHART. IN ADDITION, FINGER-TIP SELECTION OF MULTI-TEST RANGES IS PROVIDED THROUGH THE DUAL-PURPOSE CONSTRUCTION AND DESIGN OF THE PUSH BUTTON SWITCHES.

"READ METER" BUTTON. THIS BUTTON (WHEN HELD DOWN) PROVIDES THE METER READING FOR TUBE PERFORMANCE QUALITY TESTS. WHEN DEPRESSED, IT ALSO AUTOMATICALLY RELEASES ANY OTHER BUTTONS WHICH MAY HAVE PREVIOUSLY BEEN DEPRESSED.

"OFF" BUTTON. THIS BUTTON (WHEN IN THE DOWN OR DEPRESSED POSITION), SHUTS THE INSTRUMENT OFF. TO TURN THE INSTRUMENT ON, THE "READ METER" BUTTON IS DEPRESSED, RELEASING THE OFF BUTTON. IN ADDITION THE "OFF" BUTTON, WHEN DEPRESSED, SERVES AS THE HIGH CURRENT RANGE SELECTOR WHEN MULTI-RANGE FEATURES ARE EMPLOYED.

SOCKETS:

THIS INSTRUMENT INCORPORATES THE NEW 7 AND 8 PIN SUB-MINIATURES, NOVAL BUTTON 9 PIN, 8 CONTACT ACORN, LOKTAL, COMBINATION 7 PRONG. BUTTON 7 PIN, 6 PRONG. 5 PRONG AND 4 PRONG SOCKETS, AND ALSO A SPECIAL 12 PRONG SOCKET WHICH PROVIDES A CENTRALIZED TERMINAL FOR DIRECT ACCESS TO ALL 12 TUBE TESTING CIRCUITS. SEE GENERAL NOTES AND INFORMATION.

ALL TUBE ANALYSES, I.E. FILAMENT CONTINUITY, HOT CATHODE LEAKAGE, HOT NEON SHORT CHECK TUBE QUALITY TESTS AND BALLAST UNIT TESTS, ARE OBTAINED FROM EACH OF THE TEST SOCKETS, IN ACCORDANCE WITH THE TYPE OF TUBE BASE INVOLVED.

OVERHEAD CONNECTOR CAPS ("GRID CAPS")

THREE SEPARATELY FUNCTIONING GRID CAPS ARE EMPLOYED:

1. BLACK DUAL CAP (ACCOMMODATES BOTH LARGE AND SMALL TYPE TUBE-CAPS), IS USED FOR ALL SINGLE CAPPED TUBES OTHER THAN PIN TYPE CAPS.
2. RED DUAL CAP (ACCOMMODATES BOTH LARGE AND SMALL TYPE TUBE CAPS), IS USED ONLY IN CONJUNCTION WITH TUBES HAVING 2 CAPS (SUCH AS TYPE 2C22) OR IN ACCORDANCE WITH SPECIAL INSTRUCTIONS (ROLL CHART).
3. SMALL BLACK PIN CAP. USED IN CONJUNCTION WITH ACORN TYPE TUBES AND OTHERS INCORPORATING SIMILAR PIN TYPE CAPS.

THE METER IS PRODUCED TO RIGID SPECIFICATIONS BY PRECISION'S OWN METER MANUFACTURING FACILITY, PACE ELECTRICAL INSTRUMENTS CO., INC. THE METER IS A MODERN, WIDE WINDOW, EASY-READING TYPE, INCORPORATING A RUGGEDLY CONSTRUCTED, D'ARSONVAL MOVEMENT OF ~~2%~~ ACCURACY. TUBE PERFORMANCE MERIT IS READ DIRECTLY ON A NON-CONFUSING 3 COLORED REPLACE-WEAK-GOOD ARC, SUPPLEMENTED BY A LINEAR REFERENCE SCALE FOR TUBE-MATCHING PURPOSES.

TUBE-COND. SWITCH: THIS SWITCH, IN THE "TUBE" POSITION ADJUSTS THE SHORT CHECK CIRCUIT SENSITIVITY IN CONFORMITY WITH RECOMMENDED PRACTICE. IN THE "COND." TEST POSITION, EXTRA-HIGH SENSITIVITY IS PROVIDED FOR SPECIAL PURPOSE TUBE SELECTION AND QUALITATIVE CHECK OF PAPER CONDENSERS.

THE PILOT LIGHT TEST SOCKET LOCATED IN CENTER OF COMBINATION 7 PRONG SOCKET, ACCOMMODATES ALL MINIATURE SCREW AND BAYONET BASE PILOT LAMPS.

FUSE EXTRACTOR POST: THIS POST ACCOMMODATES A TYPE 3AG, 1 AMPERE FUSE, CONVENIENTLY REPLACEABLE FROM FRONT OF PANEL.

NOISE TEST PIN JACKS: THESE JACKS PROVIDE FOR AUDIBLE TUBE NOISE TESTS.

NEON LAMP SHORT INDICATOR: THIS LAMP, (A SENSITIVE G.E. TYPE NE 57), IS PROTECTED BY A REMOVABLE MAGNIFYING LENS. REPLACEMENT OF THE BULB IS SIMPLY EFFECTED AFTER THE LENS CAP HAS BEEN SLIPPED OUT. (THE LENS IS NOT SCREWED ON - IT IS A SIMPLE, POSITIVE FRICTION-FIT UNIT).

CONDENSER TEST TIP JACKS: THESE TIP JACKS PROVIDE FOR QUALITATIVE PAPER CONDENSER TESTS AND NEON LAMP CONTINUITY CHECKING.

HIGH CURRENT AND HIGH VOLTAGE JACKS: PROVIDES FOR ISOLATION OF HIGH CURRENT AND VOLTAGE RANGES. 6000 VOLT JACKS SUB-PANEL MOUNTED FOR MAXIMUM SAFETY OF OPERATOR AND INSTRUMENT.

ROLLER CHART: THE DOUBLE-WINDOW, BRASS GEARED, TUBE-TEST DATA ROLLER CHART, (ROTATED THROUGH USE OF THE THUMB-ACTUATED ROLLER WHEEL) PROVIDES FOR TROUBLE-FREE RAPID ACCESS TO ALL STANDARD TUBE TEST SETTINGS. SEE BACK OF INSTRUCTION MANUAL FOR TEST DATA COVERING SPECIAL PURPOSE TUBES AND TUBE TYPES INFREQUENTLY ENCOUNTERED.

C. GENERAL OPERATING INSTRUCTIONS

With "OFF" button depressed, connect the attachment plug of the instrument to any 50-60 cycle 110-125 volt A.C. source.

By means of the "Return Lever" on the right side of the MASTER LEVER DRUM, throw ALL levers to the NORMAL position.

Refer to the tube test roller chart for the tube test number to be tested and set CONTROLS "A", "B", "C", "D", and "E" to positions designated for that tube.

NOTE: For simplicity in locating any tube type number, it will be helpful to note that all tubes are listed in strict numerical order beginning at the top of the left hand window opening continuing downward to the end of the roll and thence to the top of the right hand window opening, etc.

Press (and then remove finger from) the "READ METER" button to turn instrument "ON". (It will be noted that the "OFF" button is thereby released to the up or ON position.) Then rotate the "LINE ADJUSTMENT" control knob to bring pointer of meter to the arrow-head, (center of scale) marked "LINE".

NOTE: "LINE" indication will be had on the meter ONLY when CONTROL "A" is set to one of the tube test positions 1 through 7.

Insert tube to be tested into its respective socket and allow the tube to heat. (Use Black or pin type overhead cap connector when necessary.) See Page 4 for use of RED cap connector. Any deviation of the meter pointer from the "LINE" position (after tube has heated) should be corrected by rotating the "LINE ADJUSTMENT" knob to bring the meter pointer back to arrow-head (center of scale).

CAUTION: In order to place the least amount of mechanical strain upon "acorn" type tubes, they should be inserted into the acorn socket in accordance with the following method: FIRST press the three grouped contacts into their corresponding socket clips; then press the remainder of the pins into place. The tube should be removed in reverse procedure.

FILAMENT CONTINUITY, HOT CATHODE LEAKAGE AND INTER-ELEMENT SHORT TESTS.

After settings are made (as noted above) WITH ALL LEVERS IN THE "NORMAL" POSITION, then proceed to obtain these tests by simply depressing the numbered push buttons 1 through 12, in consecutive order. Watch the neon lamp SHORT INDICATOR for glow or continuous flicker. The tube under test should be LIGHTLY tapped during short tests, to reveal loose elements which might become shorted under vibration.

IMPORTANT: NEON LAMP SHOULD GLOW ONLY ON THOSE BUTTONS DESIGNED ON TUBE CHART FOR FILAMENT CONTINUITY, ("FIL.CONT.") OR ON THOSE ADDITIONAL BUTTONS SPECIFICALLY NOTED ON THE ROLLER CHART.

Inasmuch as the filament of the tube under test is disengaged when the "Fil.Cont." buttons (designated on the roll chart) are depressed, it is necessary that these buttons be immediately returned to normal position (by depressing any other button) and thereby allowing the tube to remain in a heated condition for further test. The tube under test should be rejected as defective (open filament) if neon lamp fails to glow when the designated Filament Continuity Buttons are depressed.

* * * * *

DISREGARD ANY MOMENTARY NEON LAMP FLASHES AS BUTTONS ARE DEPRESSED. These flashes are merely the discharge of the blocking condenser in the short check circuit.

* * * * *

NOTE: Inasmuch as the short check push button numbers directly coincide with socket prong numbers, it becomes apparent that the operator (for short check purposes) need only depress that quantity of buttons equal to the number of socket prongs involved. For example: If tube under test inserts into the 4 prong socket, then only buttons 1 through 4 need be short-checked; if the tube inserts into the 5 prong socket, then buttons 1 through 5 are the only ones involved, etc. If a top grid cap is present, then add button #11 to the short check procedure.

A discernible neon lamp glow or continuous flicker, when any one of the numbered buttons "1 to 12" are depressed, (with the exception of the designated filament continuity buttons) indicates an inter-electrode high resistance leakage or short and the tube should be rejected without further testing, (unless otherwise noted on the tube test roller chart). Inasmuch as these tests

are made while the tube is in a heated condition, the tube should be allowed time to heat up sufficiently. In this manner, shorts or leakages that may occur due to expansion of internal elements can be more readily detected.

Because all tube elements connect to individually numbered push-buttons, there is no necessity to employ a separate cathode leakage button. Cathode leakage will be detected when the respective button (corresponding to a particular tube's cathode), is depressed.

NOTE: Push-buttons 1 through 12 are numbered in accordance with standard tube basing sequence. Should short indications be obtained on any one or more buttons, (for example on buttons 5, 6 and 8), then the tube elements, corresponding to the tube pins No. 5, 6, and 8 are either internally shorted or are connected through low leakage paths to other elements of the tube.

AUDIBLE NOISE TEST

An audible noise test of defective and noisy tubes can be had, if desired, by inserting an earphone or audio amplifier system into the "NOISE TEST" tip jacks. The testing procedure is the same as outlined for obtaining HOT CATHODE LEAKAGE TEST AND HOT INTER ELECTRODE SHORT TEST described previously.

An intermittent or constant LOUD audible hum when making CATHODE LEAKAGE AND HOT INTER-ELECTRODE SHORT TESTS, will indicate loose or shorted tube elements, a possible cause for fading and noisy radio reception. A loud audible hum when either of the "Fil. Cont." buttons is depressed, is normal and is indicative of a continuous filament.

DO NOT ATTEMPT TO OBTAIN TUBE QUALITY METER INDICATION UNTIL AFTER SHORT TESTS ARE MADE, ELSE SERIOUS DAMAGE MAY RESULT TO INSTRUMENT.

TUBE QUALITY INDICATION (TUBE PERFORMANCE MERIT)

AFTER SHORT AND FILAMENT CONTINUITY CHECKS AND LINE ADJUSTMENTS HAVE BEEN ACCOMPLISHED, throw the levers indicated (on the roll chart) under "W-X-Y-Z" to the positions called for. All other levers MUST REMAIN IN "NORMAL" POSITION.

Then depress the "READ METER" button and obtain the (PERFORMANCE MERIT) Quality Indication.

NOTE: The flexible element selection circuit of the ELECTRONOMIC TUBE AND TEST MASTERS allows for either series or parallel connection of center-tapped filaments. In order to obtain uniformity of test settings and to minimize operating errors, all tubes with center-tapped filaments are tested in parallel connection. Should the neon lamp fail to glow when any one of the push buttons (listed on the roller chart under "Fil. Cont.") are depressed, (during filament continuity test), the tube should be discarded.

If, however, one section of a center tapped filament be indicated to be open-circuited, and for some reason the operator does perform a Quality test, it will be found in many cases that a reading in the upper section of the red, "Replace" sector can be obtained. This is, of course, due to the parallel filament connection. The intact portion of the filament is still operating and causing a partial meter reading to be obtained. Such tubes should have been previously discarded as the result of the "Fil. Cont." test failure.

SPECIAL ROLLER CHART NOTATIONS

"EYE TESTS" (electron ray type indicator tubes)

By means of the flexible multi-channel circuit design of the PRECISION "MASTER" tube testers, three types of tests are performed upon standard and FM types of eye and alignment indicator tubes aside from the standard triode performance test.

Single Target Type. This type is typified by types 6E5 and 6G5: For example, a roller chart line for type 6E5 appears as follows:

TUBE	SECTION	Lever							Fil. Cont.	
		A	B	C	D	E	W	X		Y
6E5	Eye	1	1	0	0	7	-	-	2-4	-

The following test procedure must be employed:

After performing the standard "short" test, set all switches and levers as indicated on the roll chart. Depress the READ METER button and observe the circular fluorescent screen which should illuminate completely.

Next, throw the FIRST of the two levers indicated under the "Y" setting (in this example, lever 2) TO THE "Z" POSITION.

A good tube will now exhibit the typical angular shadow. Return the same first lever to its original "Y" position and note closure of the shadow angle. DISREGARD METER INDICATIONS.

Double Target Type, (Twin electron ray indicator tubes)

This type is typified by type 6AF6 and 6AD6: For example, a typical roll chart line for type 6AD6 appears as follows:

TUBE	SECTION	Lever										Fil. Cont.
		A	B	C	D	E	W	X	Y	Z		
6AD6	Eye	1	2	0	0	7	-	-	3-4-5	-	2-7	

The following test procedure must be employed:

After performing the standard "short test", set all switches and levers as indicated on the roller chart.

Depress the READ METER button and observe the circular fluorescent screen which should illuminate completely.

Next, throw the FIRST of the three levers under the "y" settings (in this example, lever 3) to the Z position. A good tube will now exhibit a typical angular shadow.

Next, throw the SECOND of the three levers under the "y" settings (in this example, lever 4) to the Z position. The tube, if good, will exhibit another angular shadow opposite the position occupied by the first shadow.

FM/AM Eye Tests (Tuning indicator tubes). This type of electron ray tube is typified by type 6AL7 and is tested simply and positively through virtue of the flexibility of the PRECISION ELECTRONAMIC TUBE MASTER SERIES.

Test procedure is as follows:

After performing the standard "short" test, set all switches and levers as indicated on the roll chart.

Depress the READ METER button and observe the two rectangular fluorescent patterns on the screen of the tube.

With the "READ METER" button depressed, throw the FIRST lever listed under the "Z" setting on the roll chart to NORMAL POSITION. One rectangular pattern should then become shorter in length; then return this lever back to its original "Z" position.

Next, throw the SECOND lever listed under the "Z" setting to NORMAL POSITION. The other rectangular pattern should then become shorter in length; then return this lever back to its original "Z" position.

Next, throw the THIRD lever listed under the "Z" setting to NORMAL POSITION. BOTH ends of the pattern (opposite to the ends noted in 3 and 4 above) should then slightly decrease in length. Observe these ends closely as the movement may be slight.

Special Rectifier Test (Types 70A7 and 117N7)

Because of unusual internal connections (plate tied to one side of filament), the 70A7 and 117N7 RECTIFIER sections require slightly special test procedures.

70A7 - Rect. Section. Set all controls and levers in accordance with the roller chart. AFTER the tube has heated sufficiently, throw BOTH levers 2 and 7 rapidly to "W" position, then quickly depress the "READ METER" button. The first meter deflection obtained is the significant reading, inasmuch as the meter reading will quickly recede coincidental with cooling of the heater.

117N7 - Rect. Section. Set all controls in accordance with roller chart. ALL levers including levers 2, 6 and 7 must FIRST be in the NORMAL position. AFTER the tube has heated SUFFICIENTLY throw lever 2 rapidly to "W" position AND lever 7 rapidly to "Y" position, then quickly depress the "READ METER" button. The first meter deflection obtained is the significant reading, inasmuch as the meter reading will quickly recede coincidental with cooling of the heater.

Special Short Indication Notes. Listings for several tubes on the roller chart bear notes indicating that certain tubes "Must show short" on one or more push button numbers in addition to the "Fil.Cont." buttons. For normal usage any tube which does NOT show short on the designated buttons should be considered a defective tube.

However due to multiple terminations of elements in many modern tubes, certain of these tubes may be salvaged for specific applications wherein the exact circuit application is known. Two of these cases are noted on the following page.

- a) TUBES WITH NEGATIVE FILAMENT CONNECTION TERMINATING IN 2 BASE PINS. SHOULD ONE OF THE TWO BASE PIN CONNECTIONS BECOME OPEN, THE TUBE MAY BE SALVAGED AND THE REMAINING PIN MAY BE USED FOR NEGATIVE FILAMENT TERMINATION ONLY IF THE CIRCUIT WILL ALLOW THE USE OF THAT PIN.
- b) TUBES WITH AN ELEMENT SUCH AS PLATE, GRID, ETC. TERMINATING AT TWO OR MORE BASE PINS. AGAIN, IF ONE TERMINATING PIN REMAINS CONNECTED TO THE ELEMENT, THE TUBE MAY BE SALVAGED IF THE CIRCUIT WILL ALLOW THE USE OF THAT PIN AND DOES NOT REQUIRE THE USE OF THE OPEN-CIRCUITED BASE PIN OR BOTH.

GAS TYPE RECTIFIERS OY4, OZ3 AND OZ4

WHEN TESTING THESE GAS RECTIFIER TYPES, IT WILL BE NOTED THAT THE METER POINTER WILL REMAIN, FOR A SHORT INTERVAL, IN THE REPLACE SECTOR AND THEN DEFLECT RAPIDLY INTO THE GOOD SECTOR. THIS CONDITION IS NORMAL FOR A GOOD GAS RECTIFIER. HOWEVER, SHOULD THE METER POINTER REMAIN CONSTANTLY IN THE REPLACE SECTOR (AFTER THE LAPSE OF SEVERAL SECONDS), THEN THE GAS RECTIFIER SHOULD BE REJECTED.

MULTI SECTION TUBE TESTS.

FULL-WAVE RECTIFIERS AND OTHER MULTI-SECTION TUBES SUCH AS DOUBLE TRIODES, TRIODE-DIODES, PENTODE-DIODES, DUO-DIODES, FREQUENCY CONVERTERS, PENTODE-TRIODES AND PENTODE-RECTIFIERS, CONTAIN EITHER A SECOND PLATE, A SECOND TRIODE OR OTHER COMBINATION OF SECTIONS. THESE TUBES ARE DESIGNATED ON THE TUBE CHART WHEREIN EACH OF THESE SECTIONS IS SEPARATELY DESCRIBED AND SETTINGS GIVEN.

TREAT EACH OF THESE SECTIONS AS IF TESTING INDIVIDUAL TUBES FOR "TUBE PERFORMANCE QUALITY", AS OUTLINED PREVIOUSLY: SET CONTROLS AND LEVERS DESIGNATED FOR EACH SECTION. THE CIRCUIT EMPLOYED IN THIS INSTRUMENT PERMITS TESTING OF THE INDIVIDUAL SECTIONS OF MULTI-SECTION TUBES AND A COMPLETE TEST MUST BE GIVEN THESE TYPES, SINCE ANY ONE POOR SECTION WILL HINDER PROPER OPERATION.

SUB-MINIATURE TUBE TESTS

THE SUBMINIATURE TYPE OF ELECTRONIC TUBES, EMPLOY CLOSELY SPACED, SEMI-FLEXIBLE LEADS FOR ELEMENT TERMINATION IN CONTRAST TO CONVENTIONAL RIGID PIN BASING. TWO SUB-MINIATURE TUBE SHAPES ARE IN PRODUCTION, THE ROUND TYPE AND FLAT TYPE. THESE ARE ACCOMMODATED BY SEPARATE ROUND AND RECTANGULAR SUB-MINIATURE SOCKETS.

THE ROUND TYPE OF SUBMINIATURE TUBE IS KEYED IN THE SAME MANNER AS A BUTTON 7 TYPE, WHICH MAKES FOR SIMPLE IDENTIFICATION FOR INSERTION IN THE SOCKET,

THE FLAT TYPE OF TUBE IS KEYED BY A RED DOT AT ONE CORNER. THE LEADS READ FROM RIGHT TO LEFT, WITH LEAD #1 NEAREST THE RED DOT. THE SOCKET IS KEYED BY A DOT (OR NIB) ON THE TOP SURFACE OF THE SOCKET. THE SOCKET CONTACT NEAREST THIS NIB IS CONTACT #1. SEE FIG. 1 BELOW.

(IN ADDITION TO THE SUB-MINIATURE TUBES MADE FOR USE WITH SOCKETS, THERE ARE ALSO TYPES WITH LONG FLEXIBLE LEADS WHICH ARE DIRECTLY SOLDERED INTO THEIR RESPECTIVE OPERATING CIRCUITS, WITH THE LEADS CUT TO VARYING LENGTHS. IN THE EVENT A TUBE OF THIS TYPE HAS TO BE REMOVED FROM ITS CIRCUIT FOR TEST, THE OPERATOR MAY FIND IT DIFFICULT TO INSERT THE TUBE LEADS INTO A TEST SOCKET. BECAUSE OF THIS, PRECISION OFFERS A SIMPLE, UNIVERSAL SUB-MINIATURE TUBE TEST ADAPTOR WITH FLEXIBLE LEADS AND POSITIVE CONTACT CLIPS. THIS SPECIAL ADAPTOR PERMITS TEST REGARDLESS OF LEAD LENGTH VARIATIONS. SEE FIG. 2 BELOW.

THIS ADAPTOR, PRECISION No. G-110, IS AVAILABLE AS AN OPTIONAL ACCESSORY, AND CAN BE OBTAINED DIRECTLY FROM YOUR DISTRIBUTOR OR THE FACTORY, AT NOMINAL COST.

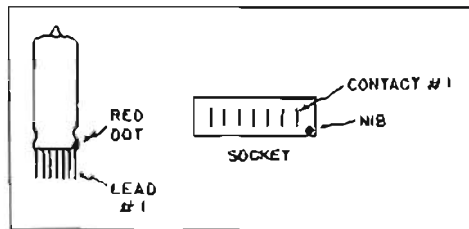

FIG. 1

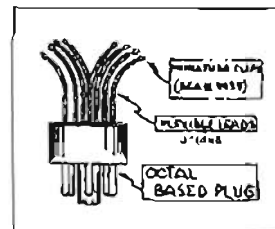

FIG. 2

TUBE BRAND VARIATIONS.

IN DETERMINING THE TUBE TEST LIMITS FOR THIS INSTRUMENT, PRECISION ENGINEERS, IN COOPERATION WITH THE ENGINEERING DIVISIONS OF LEADING TUBE MANUFACTURERS, HAVE SPENT CONSIDERABLE TIME CHECKING THOUSANDS OF TUBES FROM THE PRODUCTION RUNS OF LEADING TUBE MANUFACTURERS. FROM THE INFORMATION SO GATHERED, THE DATA ON THE ROLLER CHART, ACCOMPANYING THIS INSTRUMENT, HAS BEEN COMPILED.

INASMUCH AS EXTENSIVE AND INTENSIVE RESEARCH IS CONSTANTLY BEING MADE IN THE RADIO TUBE INDUSTRY TO IMPROVE AND STABILIZE THE ELECTRICAL AND MECHANICAL CONSTRUCTION OF TUBES, IT IS NOT UNCOMMON FOR A TUBE MANUFACTURER TO MAKE A CHANGE IN A PARTICULAR TUBE'S SPECIFICATIONS. THIS CHANGE, THOUGH NOT NECESSARILY READILY NOTICEABLE IN RADIO SET PERFORMANCE, MAY NEVERTHELESS BE MADE TO IMPROVE TUBE STABILITY AND LIFE. THIS CHANGE OR VARIATION MAY, HOWEVER, INDICATE ITSELF

on the PRECISION ELECTRONAMIC TEST MASTER and necessitate a new test limit for that particular type number.

Therefore, should a particular type number be found to vary consistently from the assigned average roller chart limits, merely redetermine the new CONTROL "D" average setting required to pass these tubes at approximately 84 of the 0-120 D.C. scale below the 3 colored tube testing arc.

It can readily be seen that a consistently low or high reading for any particular tube type of a definite manufacturer is not to be taken as indicative of a poorer or better run of tubes, nor as a defect in the tube tester.

PILOT LAMP TESTS

The miniature base socket, located in the center of the combination seven prong tube socket, accommodates all miniature screw and bayonet base type pilot lamps, Christmas tree bulbs, etc. Test procedure is as follows:

- A) SELECT PROPER FILAMENT VOLTAGE BY SETTING CONTROL "E" TO ONE OF THE FOLLOWING APPLICABLE VOLTAGES:

CONTROL "E"	VOLTS	POS.	VOLTS	POS.
	.75	1	10	9
	1.5	2	12.6	10
	2.0	3	18.9	11
	2.5	4	25	12
	3.3	5	35	13
	4.2	52	50	14
	5.0	6	70	15
	6.3	7	85	16
	7.5	8	117	17

- B) SET CONTROL "B" TO POSITION 1; TURN INSTRUMENT "ON"; ADJUST FOR "LINE"; INSERT BULB. NOTE: ALL LEVER SWITCHES MUST BE IN NORMAL POSITION.

D. BALLAST INFORMATION

BALLAST TESTING:

The neon short check circuit, in conjunction with the numbered Push-Button system provides a simple and positive method for obtaining the following ballast tests:

1. Point to point continuity test of each section of single unit as well as multiple section ballasts.
2. Tests for loose elements.
3. Tests for leakage between sections of multi-element ballasts.

NOTE: Frequently, one may encounter privately numbered ballast tubes, whose numbers have no relationship to the standard RMA Ballast Coding System. A uniform method of ballast resistor test can only be devised on the basis of some type of system. The "Precision" ballast test data, which follows, is related to the Standard RMA Code. Therefore, privately numbered ballasts should be referred to ballast manufacturer's replacement manuals for identification of this ballast in terms of the Standard RMA Code.

BALLAST RESISTOR CODE:

A sample and interpretation of the code appearing on standard octal type and replacement type ballasts are as follows:

(RMA STANDARD OCTAL TYPE) BK49AG
 (REPLACEMENT TYPE) BKX55AG

The first letter "B" on both types, if used, indicates ballast action.
 The letter "K", "L" or "M" on both types, indicates type of pilot lamp.
 The letter "X", "Y" or "Z", immediately following the pilot lamp designation, denotes a particular SERIES of base wiring and appears only on replacement type ballasts.
 The numerals "49" or "55", appearing on the respective types, indicate the total voltage drop produced by the ballast resistor including the pilot lamp.
 The letter "A" or B-C-D-E-F-G-H-J, appearing on both types (and immediately following the voltage drop numerals) designates the particular BASE WIRING Circuit used.
 The letter "G" following the base wiring circuit designation on both types, if used, merely indicates octal base glass unit, and is of no importance as far as testing is concerned.

A letter "J" following the base wiring designation such as K55CJ, refers to an internal jumper between pins 3 and 4. (See TEST PROCEDURE)

Where the letter "p" or "PR" appears after the base wiring designation, such as K55CP or K55CPR, this indicates an additional resistor section is employed for the rectifier plate circuit. (See TEST PROCEDURE)

FOR STANDARD RMA OCTAL TYPE BALLASTS, THE BASE WIRING DESIGNATION (A-B-C-D-E-F-G-H-J) IS THE ONLY INFORMATION NECESSARY FOR TEST PURPOSES.

FOR REPLACEMENT TYPE BALLASTS, THE X, Y, OR Z SERIES AND BASE WIRING DESIGNATION IS THE INFORMATION NECESSARY FOR THE TESTING OF THESE TYPES.

BALLAST TEST PROCEDURE:

The OCTAL SOCKET is used to accommodate all octal base type ballasts.

1. ALL CONTROLS AND LEVERS MUST BE IN THE FOLLOWING DESIGNATED POSITIONS BEFORE ANY ATTEMPT IS MADE TO TEST BALLAST UNITS:

Set CONTROL "A" to #1 position
 Set CONTROL "B" to #12 position
 Set CONTROL "C" to 0 position
 Set CONTROL "D" to 0 position
 Set CONTROL "E" to #18 position
Throw all levers to "NORMAL POSITION"

2. Turn instrument "ON" and adjust for "LINE" indication on meter. Insert the Ballast.
3. Classify the ballast unit to be tested according to its RMA BASE WIRING. The push buttons then to be depressed (one at a time), will correspond with the numbers designated on the appropriate schematic in Fig. 1 below;

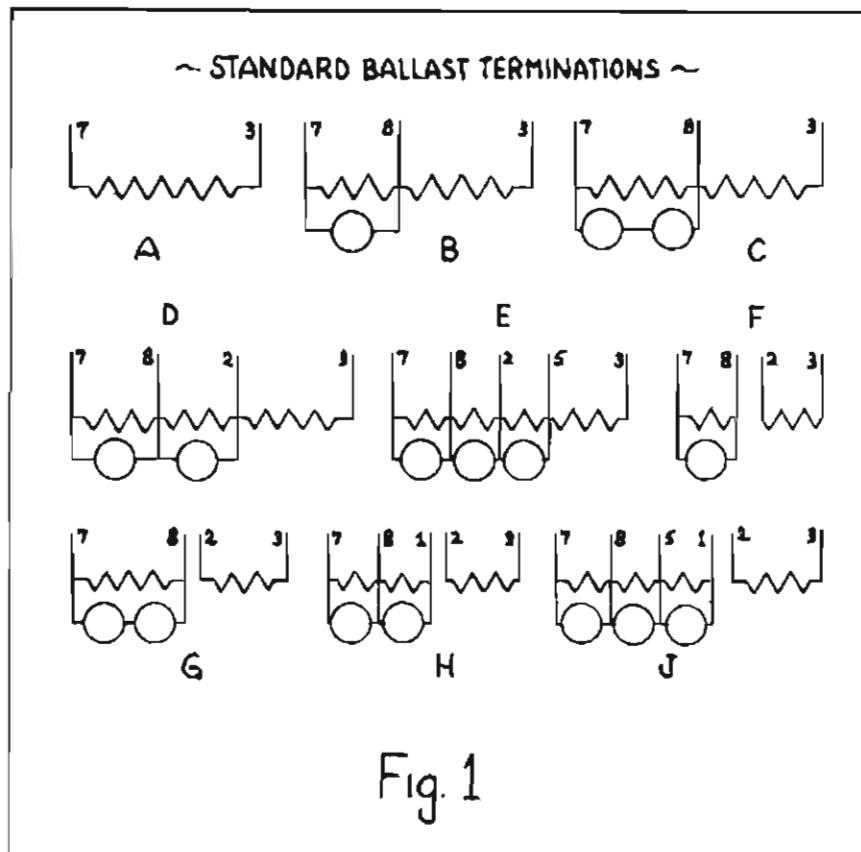

For example, Ballast type BK86A is an "A" type base wired unit. It is checked by referring to diagram "A" of Fig. 1, which reveals that button 3, then button 7 must be depressed. Neon lamp should glow as each of these 2 buttons is depressed. (Should the ballast incorporate a jumper (for example from pin 3 to pin 4 as for ballast designation BK86AJ), neon glow must also be obtained when button 4 is depressed.)

CAUTION: NEVER DEPRESS "READ METER" BUTTON DURING BALLAST TESTS.

4. A continuous neon lamp glow, after each numbered push-button (called for) is depressed, indicates that the section is not open circuited. An open section (anywhere in the chain) will cause the neon lamp to extinguish when that section's numbered button is depressed.

It is advisable to tap the ballast unit while each push-button (called for) is being depressed. In this manner, loose elements can be ascertained by noticing flickering instead of continuous glow of the neon lamp.

NOTE: Where letter "P" or "PR" follows the base wiring designation, such as BK86AP or BK86APR, then it is also necessary to depress button 5, in addition to the buttons required for the base wiring code "A".

LEAKAGE TESTS: Tests for leakages between sections of multi-section ballast units having BASE WIRING designations "R", "G", "H" or "J" are accomplished by depressing BOTH buttons 2 and 3 (simultaneously), with all other push-buttons remaining in the normal "UP" position. A neon lamp glow (if obtained) will indicate leakage or short between the two independent sections, and the ballast unit should be rejected as defective.

If any special ballast resistors are ever encountered (which cannot be identified with any standard RMA Coded basing), then merely determine the internal wiring from a service manual schematic and proceed as outlined for all ballast continuity checks.

E. QUALITATIVE PAPER CONDENSER TESTS

The jacks marked "Cond. Test" are used to obtain paper condenser tests by the sensitive neon lamp method. The self-contained power supply applies the necessary rectified voltage to the paper condenser.

PROCEDURE:

1. Connect instrument to power line and turn instrument "ON".
2. Set the "TUBE-COND." Switch, (at lower left corner of panel) to "COND." position.
3. With CONTROL "A" set to #1 position, rotate "LINE ADJUSTMENT" knob to obtain "LINE" indication on meter.
4. Insert test leads into the "COND. TEST" jacks. Apply the free ends across the paper condenser to be tested and observe the indications of the neon lamp.
 - a) A steady glow indicates a low D.C. resistance or short circuited condenser.
 - b) A continuously flickering neon glow indicates a high resistance leakage condition.
 - c) No indication of neon lamp indicates that the condenser under test is either open or the capacity is too small to cause the neon lamp to register visibly.
 - d) A good condenser will cause a momentary neon lamp flash, the duration of which is dependent upon the capacity being checked. The greater the capacity, the longer the duration and vice versa.

Polarity need not be observed when testing paper condensers.

F. BATTERY TESTING INSTRUCTIONS

The ELECTRONAMIC MASTER SERIES incorporate a highly efficient, DIRECT READING, dynamic battery performance testing circuit, developed and designed by PRECISION engineers.

Stressing extreme simplicity in both operation and readability, the PRECISION battery performance test circuit, nevertheless, DIRECTLY accommodates ALL POPULAR portable-radio "A", "B" and "C" batteries, from 1.5 through 135 volts.

Through the use of a specially designed switching circuit, each battery is TESTED UNDER LOAD, simulating operating conditions, which the battery may be required to serve in a receiver. The load conditions ARE NOT ARBITRARILY CHOSEN. The same basis applies to the calibration of each range, so that batteries will definitely be rejected when their LOADED terminal voltage no longer comes up to the stability requirements of good radio reception or similar usage.

To merely test a battery by the simple voltmeter method is entirely inadequate and inconclusive for two very obvious reasons:

- 1) The terminal voltage of used batteries differs tremendously between the LOAD conditions of actual service and the negligible current drain of the usual 1000 ohms per volt or even more sensitive voltmeter. Accordingly, a 3 volt battery may very well read full 3 volts on a VOLTMETER and nevertheless drop to less than 1 volt when subjected to receiver OPERATING LOAD (current drain).
- 2) Aside from the above, without a calibrated battery tester, the operator would have to know at what point a battery is to be considered no longer fit for service.

THESE TWO CONDITIONS OF LOAD AND REJECT POINT ARE AUTOMATICALLY ACCOUNTED FOR WHEN EMPLOYING THE SIMPLE PRECISION DYNAMIC BATTERY PERFORMANCE TESTER.

* * * * *

HOW TO TEST BATTERIES

ALL SELECTORS MUST ALWAYS BE SET TO THEIR APPROPRIATE POSITIONS BEFORE MAKING ANY BATTERY TESTS.

1. SET SELECTOR SWITCH "A" TO "BATTERY TEST".
2. SELECTOR "E", IN ADDITION TO ITS FUNCTIONS IN THE TUBE TESTING CIRCUIT, SERVES AS THE COMBINATION VOLTAGE AND LOAD SELECTOR FOR BATTERY TESTING, AND IS SET TO ITS REQUIRED POSITIONS AS FOLLOWS:

Pos. #1 - 1.5	V. BATTERIES	Pos. #52 - 9	V. BATTERIES	Pos. #10 - 67.5	V. BATTERIES
" #2 - 3	" "	" #6 - 15	" "	" #11 - 75	" "
" #3 - 4.5	" "	" #7 - 22.5	" "	" #12 - 90	" "
" #4 - 6	" "	" #8 - 30-33	" "	" #13 - 225-240	" "
" #5 - 7.5	" "	" #9 - 45	" "	" #14 - 300	" "
				" #15 - 510	" "

Once Control "A" is set to "BATTERY TEST", Selector "E" is the ONLY switch whose setting changes for batteries of different voltages. No other switches or controls are associated with battery testing.

3. Insert test leads into (-) and (+) "EXTERNAL TEST" pin jacks and apply test prods (in proper polarity) directly across appropriate terminals of battery under test (*). The meter will immediately indicate the performance condition of the battery on the "REPLACE-WEAK-GOOD" scale.

(*) CAUTION: IN THE EVENT THAT BATTERY TERMINALS ARE NOT IDENTIFIED AS TO POLARITY OR VOLTAGE, ALWAYS FIRST REFER TO RECEIVER OR BATTERY MANUFACTURER'S DATA SHEETS FOR THE NECESSARY INFORMATION BEFORE TESTING. TO AVOID THE POSSIBILITY OF OVERLOADING AND DAMAGING THE METER.

Batteries reading in the RED "REPLACE" sector should immediately and unquestionably be replaced.

Batteries reading in the YELLOW "WEAK" sector, although normally still capable of use for a short period of time, should also be replaced. "WEAK" batteries are known causes of slow "fade-outs", drift and other receiver instabilities.

NOTE 1. When testing batteries used in test equipment ohmmeter circuits, the battery may test "GOOD" and nevertheless, not give full scale meter deflection in the ohmmeter circuit. This is simply explained by reason that the rejection point of ohmmeter batteries is usually considerably above that for receivers, test oscillators and similar devices. Accordingly, as far as ohmmeters are concerned, a battery is considered unuseable when full scale ohmmeter adjustment can no longer be obtained in the particular tester in which it is employed, as described by the test equipment manufacturers.

This same battery, if it reads "GOOD", may yet nevertheless furnish some additional service in a portable radio, though, of course, its remaining useful life is considerably below that of a brand new battery, as its position on the battery test "GOOD" scale will indicate.

NOTE 2. All new batteries, regardless of voltage type, will, when new, and with the proper "E" setting, read at approximately the 79-84 indication on the 0-120 D.C. scale. SOME LITTLE VARIATION IS TO BE EXPECTED BETWEEN BATTERY BRANDS. Because one brand of new battery may read a little

higher than another, it is not an indication of a superior battery. This is attributable to certain initial chemical conditions within the battery, and in service will all average around the same operating point.

G. MULTI-RANGE AC-DC CIRCUIT TESTING

The Series 10-54 "ELECTRONAMIC" TEST MASTER, in addition to providing complete tube analyzing facilities, also incorporates a high speed multi-range PUSH BUTTON SELECTOR SYSTEM providing for the following functions:

1. A.C. voltage measurements at 1000 ohms per volt from 0 to 6000 volts.
2. D.C. voltage measurements at 20,000 ohms per volt from 0 to 6000 volts.
3. D.C. current measurements up to 12 Amperes.
4. Resistance measurements up to 60 Megohms.
5. Output meter indications up to 6000 volts.
6. Decibel readings from -10 to +77 DB.
7. D.C. current leakage measurements in electrolytic condensers.

Before use of the circuit testing functions of this instrument is attempted, note should be taken of the following important functional features:

1. Selector switch "A" controls the selection of FUNCTION, such as AC volts, DC volts, etc. In addition, when this switch is thrown to any one of the five circuit testing positions, all tube test functions, and the instrument AC power source are completely and automatically isolated and rendered inoperative. Therefore, it is of no consequence if the instrument is connected to a power source and if the instrument is ON during multi-testing. The multi-section operates as a complete unit, independent of the tube testing circuits of the instrument. In addition, it is noted that the voltage source for resistance measurements consists of completely self-contained battery supply installed as illustrated on Page 16.

2. ALL AC and DC voltage measurements are made from the two "EXTERNAL TEST" pin jacks with the exception of 1200 and 6000 volts. For these two high voltage ranges, insert negative (-) test lead into the negative (-) "EXTERNAL TEST" jack, and POSITIVE (+) test lead into the +1200 volt or +6000 volt tip jack.

ALL DC current measurements are also made from the "EXTERNAL TEST" pin jacks with the exception of the 1.2 (1200 MA) and 12 ampere ranges, which require use of the negative (-) "EXTERNAL TEST" tip jack and the +1.2 or +12 Ampere tip jack.

3. FOR MULTI-TESTING, ONLY THE FOLLOWING CONTROLS AND SWITCHES (OTHER THAN THE PUSH BUTTONS) ARE USED:
 - a) Switch A. Set to the desired FUNCTION as indicated on the panel. The Multi-section will NOT operate should control "A" be set in positions 1 through 7, or on "BATTERY TEST".
 - b) Control C. Operates as the "ohms adjust" control for zero adjustment of resistance ranges.

AC VOLTAGE MEASUREMENTS: 1000 ohms per volt sensitivity

Rotate Selector Switch "A" to "A.C. VOLTS" position. Insert test leads into (-) "EXTERNAL TEST" (+) pin jacks. Depress the appropriate range push button in the group marked "VOLTAGE"

The four voltage range push buttons read from left to right:

6V. - - - 12V. - - - 60V. - - - 300V.

AC voltage measurements are read on the RED A.C. CORRECTION SCALE as follows:

0-6V. read on 60 scale, divide by 10
 0-12V. read on 120 scale, divide by 10
 0-60V. read directly on 60 scale
 0-300V. read on 30 scale, multiply by 10
 * 0-1200V. read on 120 scale, " 10
 * 0-6000V. read on 60 scale, " " 100

* CAUTION: ALL A.C. VOLTAGE MEASUREMENTS ARE MADE WITH TEST LEADS INSERTED INTO THE MINUS (-) AND PLUS (+) "EXTERNAL TEST" JACKS EXCEPT FOR THE 1200V. AND 6000V. RANGES. FOR THESE RANGES, DEPRESS THE "300V." PUSH BUTTON, INSERT ONE TEST LEAD INTO THE NEGATIVE (-) "EXTERNAL TEST" JACK AND THE OTHER TEST LEAD INTO EITHER THE 1200V. A.C. OR 6000V. A.C. JACK.

D.C. VOLTAGE MEASUREMENTS: 20,000 ohms per volt

Rotate switch "A" to "D.C. VOLTS" position. Then depress the appropriate range push button corresponding to the range desired in the sector marked "VOLTAGE".

The four voltage range push buttons read from left to right:

6V. - - - 12V. - - - 60V. - - - 300V.

D.C. voltage measurements are read on the BLACK D.C. scale as follows:

- 0-6V. read on 60 scale, divide by 10
- 0-12V. read on 120 scale, divide by 10
- 0-60V. read directly on 60 scale.
- 0-300V. read on 30 scale, multiply by 10
- * 0-1200V. read on 120 scale, " 10
- * 0-6000V. read on 60 scale, " 100

* CAUTION: ALL D.C. VOLTAGE MEASUREMENTS ARE MADE WITH TEST LEADS INSERTED INTO THE MINUS (-) AND PLUS (+) "EXTERNAL TEST" JACKS EXCEPT FOR THE 1200V. AND 6000V. RANGES. FOR THESE RANGES, DEPRESS THE "300V." PUSH BUTTON, INSERT ONE TEST LEAD INTO THE NEGATIVE (-) "EXTERNAL TEST" JACK AND THE OTHER TEST LEAD INTO EITHER THE 1200V. OR 6000V. D.C. JACK. ALWAYS OBSERVE PROPER TEST LEAD POLARITY WHEN MAKING D.C. MEASUREMENTS.

IMPORTANT PRECAUTIONS
When Testing High Voltage Circuits

NEVER attempt adjustment or test of any circuits (such as television receivers) wherein exceedingly dangerous, high voltages are present unless a complete circuit diagram is available to identify the location of all high potential terminals. Always employ well insulated test leads, such as the PRECISION Extra-High Voltage Super-Flex Test Leads, Part #228. Available from PRECISION distributors and factory.

* * * * *

Make sure hands and shoes are DRY when performing tests wherein high voltage is involved.

* * * * *

When voltage or current of unknown value is to be measured, it is advisable to employ the highest range first. If meter indication is slight, then select next lower range, etc. Adhere closely to the above in order to prevent slamming of meter pointer and meter overloading.

D.C. CURRENT MEASUREMENTS: Microampere and Milliampere Ranges

Rotate Selector "A" to "D.C. MILS." position. Insert test leads into the "EXTERNAL TEST" pin jacks. Depress the appropriate range push button in the group marked "CURRENT". These buttons read from left to right:

120 MA. - - - 12 MA. - - - 1.2 MA. - - - 120 Microamperes

* For special 60 microampere range, see instructions below.

D.C. Current measurements are read on the BLACK D.C. scale as follows:

- 0-120 MA read directly on 120 scale
- 0-12 MA read on 120 scale, divide by 10
- 0-1.2 MA read on 120 scale, divide by 100
- 0-120 microamperes read directly on 120 scale
- * 0-60 microamperes read directly on 60 scale

* To operate the 60 microampere range, insert negative test lead into the minus (-) "EXTERNAL TEST" tip jack and the positive (+) test lead into the "60 microampere" tip jack. It is NOT necessary to depress any push button in the push button "CURRENT" group. It is also of no consequence if any of the "CURRENT" buttons are depressed.

All current measurements are made with test leads in series with circuit under test. Observe proper polarity at tip jacks.

D.C. HIGH CURRENT MEASUREMENTS: (1.2 and 12 Amperes)

Rotate Selector "A" to "D.C. AMPS" position. Depress the "1.2 and 12 AMPS" push button.

Insert negative test lead into the negative (-) "EXTERNAL TEST" pin jack and positive test lead into either the 12 AMPS or 1.2 AMPS pin jack. Read on D.C. scale as follows:

0-1.2 AMPS read on 120 scale, divide by 100
0-12 AMPS read on 120 scale, divide by 10

NOTE: When using the 12 Ampere D.C. range, never remove tip jacks while current is flowing through the circuit. Failure to observe this precaution may result in arcing at the tip jacks, being removed, and though the meter would not be damaged, the jack would gradually char.

RESISTANCE MEASUREMENTS

Rotate Selector "A" to "Resistance" position. Then select resistance range by depressing the appropriate button in the push button group marked "Resistance". These buttons read from left to right:

6000 ohms; 600K ohms (600,000 ohms); 6 megohms; 60 megohms
(Rx1) (Rx100) (Rx1000) (Rx10,000)

Test leads are inserted into the regular (-) and (+) "EXTERNAL TEST" tip jacks. After selecting the desired range, SHORT the test lead tips together and rotate "C" control knob (ohms adjust) to obtain full scale deflection. Proceed with resistance measurements and read on "OHMS" arc as follows:

0-6000 ohms range (35 ohms at center scale) read directly (Rx1)
0-600K ohms range (3500 ohms at center scale) multiply reading by 100 (Rx100)
0-6 Megohms range (35,000 ohms at center scale) multiply reading by 1000 (Rx1000)
0-60 Megohms range (350,000 ohms at center scale) multiply reading by 10,000 (Rx10,000)

CAUTION: ALWAYS FIRST DISENGAGE ONE END OF RESISTANCE FROM THE CIRCUIT BEFORE MAKING RESISTANCE MEASUREMENTS, OR ELSE AN INDICATION OF THE TRUE RESISTANCE VALUE MAY NOT BE OBTAINED DUE TO THE POSSIBILITY OF THE CIRCUIT THEREIN INVOLVED EFFECTIVELY SHUNTING THE RESISTANCE TO BE MEASURED, THUS REDUCING THE TRUE READING BY AN AMOUNT PROPORTIONATE TO THE RESISTANCE OF THE INCLUDED SHUNT NETWORK.

NOTE: The first three ohmmeter ranges are powered by three 1½ volt flash-light cells in series connection. (Eveready #935, Burgess #1 Uni-Cell or equal). The 60 Megohm (fourth range) is powered by a 45 volt #455 Eveready or Burgess #XX30 battery or equal.

Batteries are installed in accordance with Fig. 4 (see next page) and should be replaced at such time as full scale deflection can no longer be obtained.

OUTPUT METER INDICATIONS:

The A.C. voltage measurements at a high sensitivity of 1000 ohms per volt, makes this instrument ideally suitable for use as an output meter.

There are two methods that can be used for obtaining output meter indications as listed below:

In the first method, make connections from the voice coil of speaker or secondary of output transformer to the "EXTERNAL TEST" tip jacks. In the event that D.C. voltage is present or else easy access to the voice coil or secondary of transformer cannot be had, then refer to the method outlined below.

In the second method, make connections from plate of output tube and ground or chassis of radio receiver to "EXTERNAL TEST" tip jacks with a .1 mfd., 600 volt condenser connected in SERIES with the positive test lead, to block any D.C. component.

NOTE: When employing voltage ranges beyond 600 volts for output indications, it is necessary to insert an additional .1 mfd. condenser in series with the condenser noted above or a single unit of appropriately higher voltage rating. The voltage rating of this additional external condenser should be comparable to the maximum voltage appearing at the circuit being measured.

PROCEDURE:

With the use of either method, just previously noted, rotate Selector "A" to "A.C. VOLTS" and depress the highest voltage button in the push button "Voltage" group. An output meter indication will be had when a signal generator and radio receiver are put into operation. If the meter indication is slight, then use the next lower A.C. voltage push button range, etc.

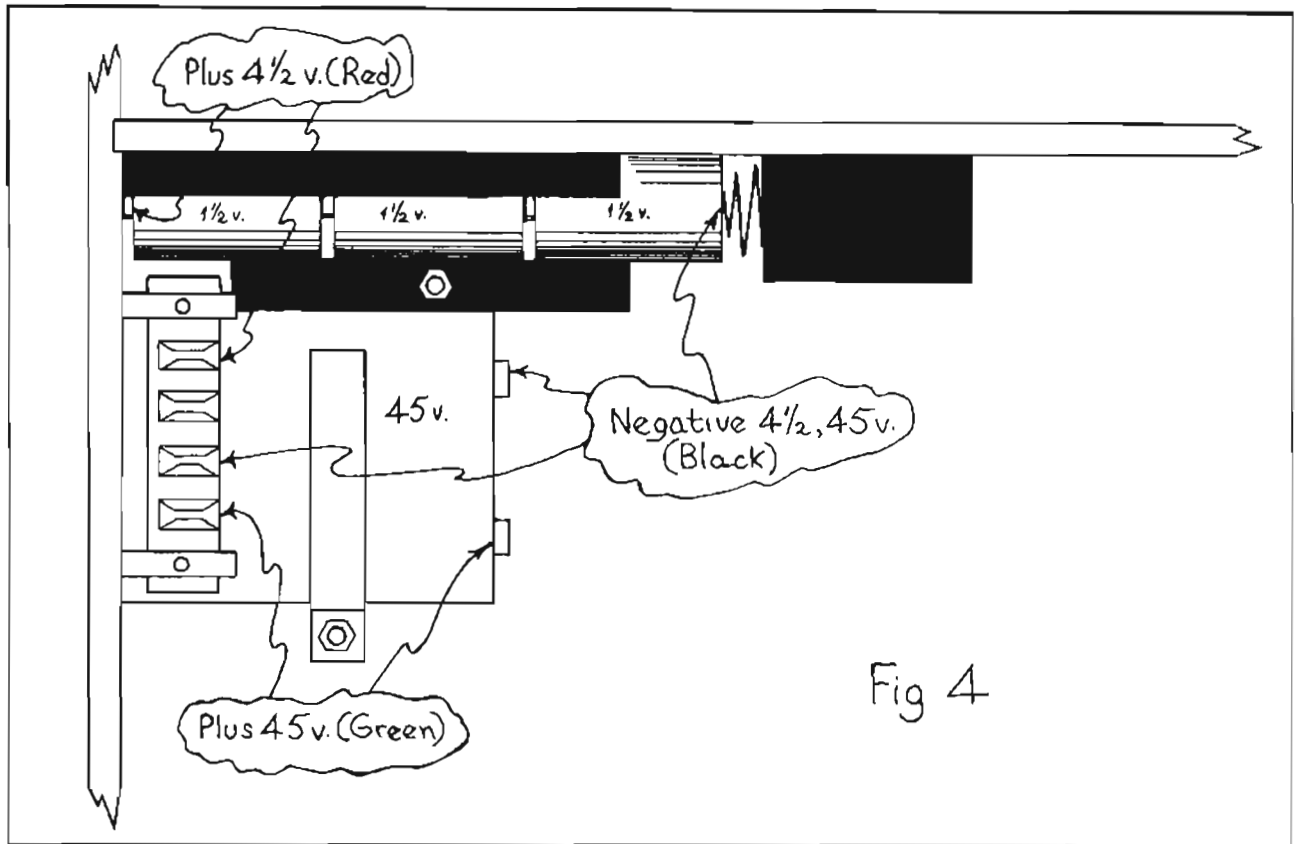

Fig 4

ANY GAIN OR LOSS AS A RESULT OF BALANCING OR TRIMMING WILL BE NOTED BY CORRESPONDING METER POINTER DEFLECTION.

NOTE: THE OUTPUT METER CAN ALSO BE USED TO GREAT ADVANTAGE FOR OBTAINING COMPARISONS IN TUBE PERFORMANCE BY NOTING THE DIFFERENCE IN METER INDICATIONS WHEN ANY OR ALL OF THE TUBES ARE SUBSTITUTED IN THE RADIO RECEIVER UNDER TEST.

DECIBEL METER:

THIS INSTRUMENT INCORPORATES A DIRECT READING AND CALIBRATED DECIBEL SCALE ENABLING READINGS FROM -10 TO +77 DB, IN SIX RANGES.

THE DB SCALE READING (-10 TO +17 DB) IS BASED UPON A ZERO LEVEL OF 1 MILLIWATT (OR .7746 VOLTS) ACROSS A 600 OHM LOAD. THE MOST COMMON USE OF A DECIBEL METER IS AS A POWER LEVEL INDICATOR ACROSS KNOWN IMPEDANCES. BECAUSE OF CALIBRATION AT ONE DEFINITE IMPEDANCE, CONVERSIONS MUST BE MADE TO THE NEW IMPEDANCE WHEN USED AT OTHER THAN 600 OHMS. SUCH TABLES MAY BE FOUND IN A MULTIPLICITY OF TEXTBOOKS AND OTHER TECHNICAL PUBLICATIONS.

REFER TO DECIBEL CONVERSION TABLE, AT THE REAR OF THIS BOOKLET, FOR INTERPRETATION OF DECIBEL READING IN TERMS OF POWER RATIO AND VOLTAGE RATIO.

CAUTION MUST BE OBSERVED IN THE USE OF THE DB RANGES THAT THE CIRCUIT ACROSS WHICH THE METER IS PLACED IS ISOLATED FROM ALL D.C., ELSE THE METER MAY BE DAMAGED OR AT LEAST ERRONEOUS READINGS OBTAINED, DEPENDING UPON WHETHER THE D.C. VOLTAGE IS GREATER OR LESS THAN THE VOLTAGE SCALE TO WHICH THE DECIBEL SCALE CORRESPONDS. A .1 MFD. 600 VOLT CONDENSER SHOULD BE CONNECTED IN SERIES WITH ONE TEST LEAD IF D.C. VOLTAGE IS PRESENT IN ANY CIRCUIT WHEREAT DB TESTS ARE TO BE MADE.

PROCEDURE:

MAKE CONNECTIONS ACROSS 600 OHM LOAD TO "EXTERNAL TEST" TIP JACKS. ROTATE SELECTOR "A" TO "A.C. VOLTS" FOR ALL DECIBEL READINGS. SELECT DESIRED DB RANGE BUTTON ON THE "VOLTAGE" PUSH BUTTONS AS FOLLOWS:

- 10 DB TO +17 DB RANGE, DEPRESS "6V." BUTTON AND READ DB SCALE DIRECTLY
- To +23 DB " " " 12V. " " ADD +6 DB TO SCALE READING
- To +37 DB " " " 60V. " " ADD +20 DB TO SCALE READING
- To +51 DB " " " 300V. " " ADD +34 DB TO SCALE READING
- To +63 DB " " " 300V. " INSERT TEST LEADS INTO (-) "EXTERNAL TEST" AND +1200V. JACKS --- ADD +46 DB TO SCALE READING
- To +77 DB RANGE, DEPRESS 300V. BUTTON, INSERT TEST LEADS INTO (-) "EXTERNAL TEST" AND +600V. A.C. JACKS --- ADD +60 DB TO SCALE READING

CURRENT MEASUREMENTS OF LEAKAGE IN ELECTROLYTIC CONDENSERS;

The leakage in an electrolytic condenser is measured in terms of D.C. current (per microfarad) flowing through the condenser when rated D.C. voltage is applied.

All electrolytic condensers contain some inherent current leakage. However, if leakage above an allowable amount is present, it may then be termed as poor. An allowable current leakage is dependent upon such factors as age and manufacturers' specifications of a condenser, design of power unit, filter system and rectifier tube of the radio receiver in which the condenser is incorporated. In general, considering an 8 mfd. condenser THAT HAS BEEN IN USE (rated at 450 volts), the maximum allowable leakage is approximately .5MA per microfarad or 4 MA total.

The following will serve as a basis for computing approximate allowable leakages:

- a) For condensers rated at 300 volts or more, leakages of approximately .5 MA per microfarad are permissible.
- b) For condensers rated between 100 to 275 volts, permissible leakages are approximately .2 MA per microfarad.
- c) For condensers rated below 100 volts, permissible leakages are approximately .1 MA per microfarad.

CAUTION: WHEN OBTAINING ELECTROLYTIC LEAKAGE MEASUREMENTS, HIGH VOLTAGE IS EMPLOYED. IT IS THEREFORE IMPORTANT THAT THE FOLLOWING INSTRUCTIONS BE ADHERED TO IMPLICITLY, TO PREVENT DAMAGE TO METER.

PROCEDURE:

With condenser disconnected from radio receiver circuit, CHECK CONDENSER FOR SHORT with ohmmeter, using the 0-600,000 ohms range. POLARITIES MUST BE OBSERVED. The negative "EXTERNAL TEST" tip jack is connected to the anode or positive terminal of condenser and the positive "EXTERNAL TEST" tip jack is connected to the negative terminal of condenser. A decided low resistance reading or constant full scale deflection of ohmmeter pointer indicates that the condenser is shorted and should be rejected WITHOUT FURTHER TESTING.

When an electrolytic incorporated in a radio receiver is to be tested, the necessary operating voltage is automatically applied and the following connections are made for "forming" and measuring the current leakage, after being (ohmmeter) tested for short.

1. Rotate Switch "A" to "D.C. MILS" position, and depress 120 MA CURRENT push-button.
2. Remove lead going to (positive) anode terminal of condenser and connect this lead to positive "EXTERNAL TEST" tip jack with a PROPER LIMITING RESISTOR IN SERIES. Where voltage applied to condenser is above 100 volts, the limiting resistor should be approximately 4000 ohms. When the applied voltage is below 100 volts, the value of the limiting resistor should be approximately 1000 ohms. This limiting resistor is very important and should not be omitted.
3. Connect the negative "EXTERNAL TEST" tip jack to the (positive) anode terminal of condenser. (From the above connections, it can be seen that the "EXTERNAL TEST" tip jacks, limiting resistor, condenser terminal and voltage source are in series connection.)
4. After series connections are made, turn on switch of radio set. The meter pointer may now deflect to near full scale and then gradually recede toward the zero mark or near to zero, after the expiration of about three minutes. THIS PROCEDURE IS KNOWN AS "FORMING" THE CONDENSER.

NOTE: A steady meter pointer indication without receding towards or near to zero (after forming process) indicates a shorted or leaky electrolytic and the condenser should be rejected WITHOUT FURTHER TESTING.

5. After "forming", short out the limiting resistor and read current leakage of condenser under test, directly on the 120 MA scale. If meter indication is under 12 MA, depress the 12 MA button for a better meter indication and read on 12 MA scale, etc. (For computation of permissible condenser leakage, refer to basis noted previously.)

CAUTION: AFTER THIS TEST IS COMPLETED, ALWAYS FIRST DISCONNECT THE NEGATIVE TEST LEAD FROM CIRCUIT BEFORE TURNING OFF POWER SUPPLY TO PREVENT SLAMMING OF METER POINTER DUE TO DISCHARGE OF CONDENSER UNDER TEST.

To test electrolytic condensers not incorporated in a radio set, an external D.C. power supply is necessary; preferably one that employs various voltage taps suitable for application of the various condenser voltage ratings. In this case, adhere to the same testing procedure as noted above in paragraphs 1, 4 and 5, but making the following series connections:

- a) Select voltage tap of D.C. power supply approximating the rated voltage of condenser to be tested.
- b) Connect positive terminal of power supply to the positive "EXTERNAL TEST" tip jack with a 4000 ohm limiting resistor in series, if applied potential is above 100 volts. If potential is 100 volts or under, use a 1000 ohm limiting resistor.
- c) Connect negative terminal of power supply to negative terminal of condenser.
- d) Connect negative "EXTERNAL TEST" tip jack to the (positive) anode terminal of condenser.
- e) Refer to paragraphs 1, 4 and 5 for obtaining current leakage measurements.

H. SERVICE DATA

The PRECISION ELECTRONAMIC TUBE AND TEST MASTERS have not only been designed to accurately indicate the overall performance merit of vacuum tubes, but have been constructed to withstand the abuses of general field use. All components have been exhaustively sample-tested by Precision's Test Engineering Laboratory and have been approved for general long-life usage. Generous mechanical design insures maximum resistance to physical damage. Rugged overall mechanical and electrical design is a major Precision precept.

However, . . . it is impossible to fully control the two major contributions to inoperative instruments namely:

- 1) Failure of components after instruments have passed Precision's Performance Test Department and
- 2) Damage of components due to misoperation, accidental or otherwise, including failure to OBSERVE PRESCRIBED OPERATING PROCEDURES.

Therefore, in order to expedite rehabilitation of your instrument, (should the need arise), the most commonly encountered possible failures and recommended remedial measures therefor are listed as follows:

IMPORTANT NOTE: Your PRECISION ELECTRONAMIC TUBE OR TEST MASTER is a relatively complex instrument, and has been carefully inspected and calibrated by Precision's Performance-Test Department. - - DO NOT attempt repairs or modifications other than those listed below unless upon specific recommendation by Precision's SERVICE DEPARTMENT.

1. Instrument does not become energized upon application of line voltage and release of "OFF" button.
 - a) Remove 3AG, 1 ampere fuse from panel mounted fuse holder. If blown, replace with same size and type fuse only if the cause for blowing of fuse is known and has been remedied.

Reasons for fuse-blowing may be:

Failure to short-check a tube before attempting quality test.
Shorted power transformer windings or other internal shorts.
2. Several type tubes with the same "A" switch setting do not provide meter merit indications.
 - a) The load resistor associated with the particular "A" switch position may be open. Refer to schematic, then Fig. 2 (Page 19), disconnect the resistor in question and check with an ohmmeter. If open circuited, contact Precision's Service Department for a replacement resistor.
3. Meter does not indicate "Line" check when instrument is energized.
 - a) Remove 5Y3 rectifier tube and replace if defective.
4. "Line" adjustment is erratic.
 - a) Examine Line potentiometer item #R33 ("Line Adjustment") for shorted, open or worn turns. Unsolder the three leads and check for continuity with an ohmmeter. If defective, contact Precision's Service Department.
5. Erratic checks of several tubes with the same type base.
 - a) Examine that particular socket contact and check for being loose or broken. If new sockets are required, contact Precision's Service Department or your parts distributor.
6. Tubes with overhead caps check improperly.
 - a) Check cap leads for continuity especially at the cap end. Continuous use and attendant flexing of the wire occasionally causes breakage.

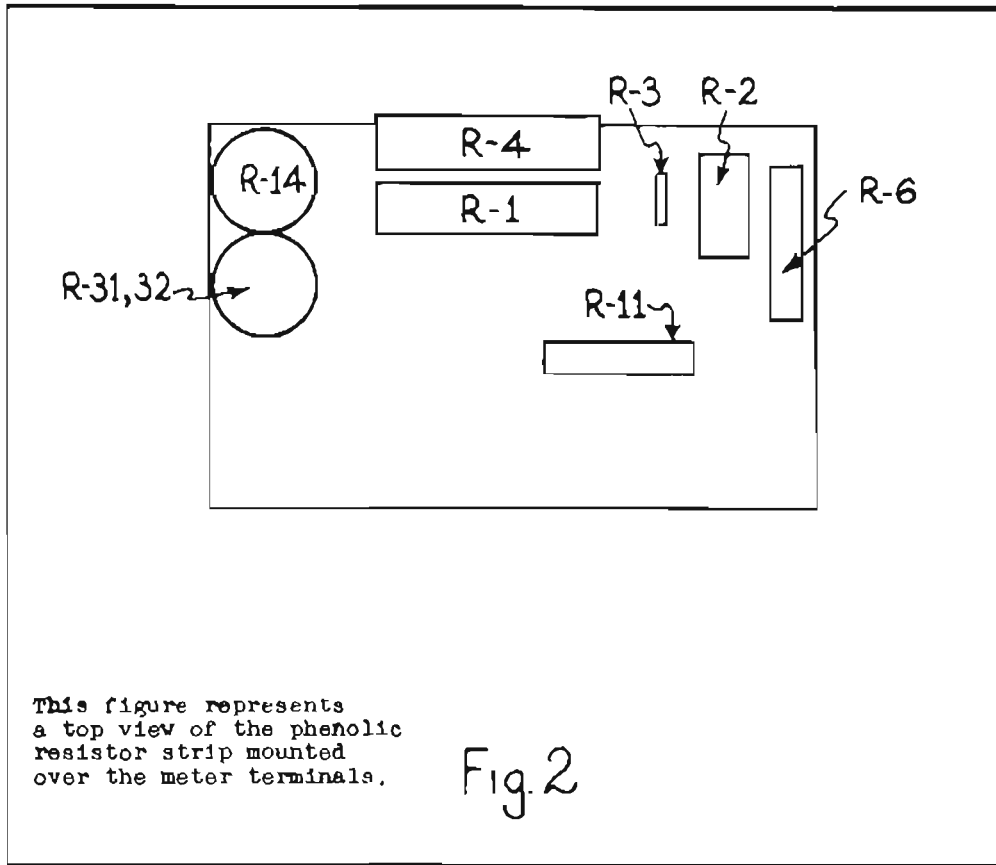

7. IMPROPER OPERATION OF BATTERY TEST AT ANY ONE POSITION OF SWITCH "E"
 - a) CHECK BATTERY NETWORK RESISTORS WITH AN OHMMETER.
 - b) SHOULD THE METER READ OFF-SCALE ON BATTERY TEST, CHECK SHUNT RESISTOR R30, 31 AND 32 FOR OPEN CIRCUIT.
ALL REPLACEMENT ITEMS ARE OBTAINABLE THROUGH CONTACT WITH PRECISION'S SERVICE DEPARTMENT.
8. APPARENT DEFECTIVE OPERATION OF THE INSTRUMENT METER.
 - a) REPAIR AND RECALIBRATION OF THE METER OF AN ELECTRONAMIC TEST MASTER IS A DELICATE AND HIGHLY SPECIALIZED OPERATION. DO NOT ATTEMPT TO REPAIR AN INOPERATIVE METER --ALWAYS CONTACT PRECISION'S SERVICE DEPARTMENT SHOULD YOUR METER APPEAR DEFECTIVE OR DAMAGED.
9. SHOULD ANY ONE OR MORE OF THE MULTI-RANGES OF THE INSTRUMENT APPEAR INOPERATIVE OR INACCURATE DUE TO MISOPERATION OR OTHER REASONS, A COMPLETE AND DETAILED DESCRIPTION OF THE TROUBLE ENCOUNTERED SHOULD BE SUBMITTED TO PRECISION'S SERVICE DEPARTMENT. IF DIFFICULTY CAN BE SIMPLY RECTIFIED VIA CORRESPONDENCE, IT WILL BE SO HANDLED. OTHERWISE RETURN WILL BE SUGGESTED IN KEEPING WITH OPERATOR'S OWN BEST INTERESTS.

SPECIAL NOTE RE REPAIR SERVICE

WHEN RETURNING A PRECISION INSTRUMENT FOR REPAIR-RECALIBRATION SERVICE, ALWAYS PACK CAREFULLY IN A STRONG, OVERSIZED CORRUGATED SHIPPING CONTAINER, USING A GENEROUS SUPPLY OF PADDING SUCH AS EXCELSIOR, SHREDED PAPER, OR CRUMPLED NEWSPAPER. THE ORIGINAL CONTAINER AND FILLING PADS (IF AVAILABLE) IS IDEAL FOR THIS PURPOSE. PLEASE SHIP VIA RAILWAY EXPRESS PREPAID AND MARK FOR:

PRECISION APPARATUS COMPANY, INC.
70-31 84TH STREET
GLENDALE 27, L.I., N.Y.

ATT: SERVICE DIVISION

FRAGILE LABEL SHOULD APPEAR ON AT LEAST FOUR SIDES OF THE CARTON.

NEVER RETURN AN INSTRUMENT UNLESS IT IS ACCOMPANIED BY FULL EXPLANATION OF DIFFICULTIES ENCOUNTERED. THE MORE EXPLICIT THE DETAILS, THE MORE RAPIDLY YOUR INSTRUMENT CAN BE HANDLED AND PROCESSED.

1. GENERAL NOTES AND INFORMATION

1. THE 12 PRONG SOCKET: ALTHOUGH NO KNOWN PRESENT DAY TUBES HAVE A BASE CORRESPONDING TO THIS SPECIAL 12 PRONG SOCKET, IT AFFORDS ONE CONVENIENT AND CENTRALIZED MASTER LOCATION WHEREAT ALL 12 TUBE TESTING CIRCUITS APPEAR.

IT THEREFORE BECOMES A SIMPLE AND STRAIGHTFORWARD MATTER TO STANDARDLY ACCOMMODATE ANY TYPE OF ADAPTER THAT MAY EVER BE REQUIRED FOR FUTURE TUBE DESIGNS UP TO AND INCLUDING 12 ELEMENT TERMINATIONS. ALL SUCH FUTURE TUBE ADAPTERS WOULD THEN EMPLOY THE SAME STANDARDLY AVAILABLE 12 PRONG PLUG BASE.

2. TEST SET ACCURACY: SEE NEXT PAGE.

NEW TUBE TEST DATA

IN LINE WITH "PRECISION'S" DESIRE TO EXTEND UTMOST SERVICE TO USERS OF "PRECISION" TEST EQUIPMENT, NEW TUBE TEST DATA IS NOW BEING MADE AVAILABLE ON A SPECIAL SUBSCRIPTION BASIS.

THIS PLAN ENTITLES THE SUBSCRIBER TO RECEIVE, AUTOMATICALLY, 2 UP-TO-DATE ROLL CHARTS AND A MINIMUM OF 2 ADDITIONAL SUPPLEMENTS DURING A ONE YEAR SUBSCRIPTION PERIOD.

NOTE FOR NEW OWNERS: - THE FIRST YEAR'S SUBSCRIPTION IS ENTERED FREE OF CHARGE UPON OUR RECEIPT OF YOUR REGISTRATION-SUBSCRIPTION CARD COVERING THE PURCHASE OF A NEW "PRECISION" TUBE TESTER.

IT IS IMPORTANT THAT THIS REGISTRATION-SUBSCRIPTION CARD BE COMPLETELY FILLED-IN AND RETURNED TO US IMMEDIATELY, IN ORDER THAT YOU MAY RECEIVE THE FULL BENEFITS OF THIS SPECIAL SERVICE.

PLEASE NOTE:

UPON OUR RECEIPT OF YOUR REGISTRATION-SUBSCRIPTION CARD WE WILL RESPOND WITH TWO SEPARATE CARDS:-

- A) ONE CARD ACKNOWLEDGES WARRANTY REGISTRATION OF YOUR NEW TUBE TESTER.
- B) THE OTHER CARD, (WHICH WILL FOLLOW IN A FEW DAYS LATER), CONFIRMS YOUR ONE YEAR FREE TUBE TEST DATA SUBSCRIPTION.

UPON EXPIRATION OF THE FIRST ONE YEAR'S FREE SUBSCRIPTION, YOU WILL HAVE THE OPPORTUNITY TO RENEW THE SAME EFFICIENT SERVICE FOR THE NOMINAL CHARGE OF ONLY \$2.00 PER YEAR. ADEQUATE ADVANCE NOTICE OF END OF SUBSCRIPTION IS SENT TO ALL SUBSCRIBERS.

FOR THOSE WHO MAY NOT WISH TO RENEW THIS AUTOMATIC SERVICE, CHARTS WILL BE AVAILABLE, UPON REQUEST, AT THE NOMINAL COST OF \$1.00 EACH. IT IS VERY IMPORTANT THAT SUCH SEPARATE ROLL CHART REQUESTS LIST THE FOLLOWING INFORMATION:-

- A. MODEL NO. OF TUBE TESTER
- B. SERIAL NO. OF TUBE TESTER
- C. FORM NO. OF YOUR PRESENT CHART (PRINTED AT UPPER LEFT-HAND CORNER OF CHART)

THIS INFORMATION PERMITS OUR TUBE TEST DATA DEPT. TO RESPOND WITH THE CORRECT CHARTS FOR YOUR PARTICULAR TUBE TESTER.

SPECIAL NOTE: PAID SUBSCRIPTION SERVICE APPLIES ONLY TO CONTINENTAL U.S.A., CANADA AND U.S. POSSESSIONS.

* * * * *

PRECISION APPARATUS COMPANY, INC.
70-31 84TH STREET,
GLENDALE 27, L.I., N.Y.
U.S.A.

M. ALPHABETICAL INDEX TO CONTENTS

	Page		Page
Abnormal readings	18	Line Adjustment	3
Accessories	20	Line Potentiometer	18
A.C. Voltage Measurements	13	Meter	2, 19
Acorn Tube Testing	5	Multi-test Features	2
Adapter G-110	8	Neon lamp	4
Ballasts, basing (Fig. 1)	10	Neon lamp flashes	5
Ballasts, leakage tests	11	Noise test	6
Ballast Resistor Code	9	"Normal" position Lever Switch	3
Ballast, test procedure	10	Notations, Roller Chart	6
Basing, Ballasts.	10	"OFF" button	5
Batteries, installation	16	Ohmmeter, battery-testing	12
Battery testing	11	Ohms Adjust	15
Battery testing, ohmmeter batteries	12	Output Meter Indications	15
Caps, Grid.	4, 18	Pilot lamp tests	4, 9
Center Tapped Filaments	6	Push Button System	4
Condenser tests (paper)	11	Quality, Indication	6
Condenser tests (electrolytic)	17	"Read Meter" Button	4, 6
Continuity, filament	5	Rectifiers, gas	8
Converter tests	8	Rectifier test, special	7
Controls:		Resistance Measurements	15
"A"	2	Resistor, Ballast, code	9
"B"	3	Roller Chart	4, 20
"C"	3	Roller Chart Notations	6
"D"	3	Scale, Linear	1
"E"	3	Service Data	18
Current Measurements	14	Short tests	5
Decibel Measurements	16	Sockets	4
Eye Tests, single target type	6	Special Rectifier tests	7
Eye Tests, double target type	7	Special Short Indication notes	7
Eye Tests, FM/AM type	7	Sub-miniature Tube tests	8
Filament Continuity	5	Switch, "Tube" - "Cond".	4
Filaments, tapped	6	Tapped Filaments	6
Filament Voltages	3, 9	Tube Brand Variations	8
FM/AM Eye tests	7	"Tube"- "Cond." switch	4
Fuse	18	Voltages, Battery	12
Gas Rectifiers	8	Voltages, Filament	9
Grid Caps	4, 18	Voltage Measurements, A.C.	13
Guarantee Card	20	Voltage Measurements, D.C.	14
Hum	6		
Instructions, Operating	5		
Lamp, neon	4		
Lamp, pilot tests	9		
Leakage tests, Ballasts	11		
Lever Switch, example of setting	3		



-PRECISION- *Electronamic* TUBE TESTER

*Reg. U.S. Patent Office

PRINCIPLES OF ELECTRONAMIC TUBE TESTING

The All-Inclusive, Single-Operation, Positive Vacuum-Tube Performance Test!
More than just Mutual Conductance

☆ A most perplexing issue confronting the radio service engineer is the choice of tube testing equipment that will solve his tube test problems with **greatest possible accuracy and reliability**. With this thought foremost in mind, "PRECISION" engineers have devoted unlimited time in extensive vacuum tube testing research and development.

All varieties of tests were conducted upon thousands of tubes, at our own fully equipped laboratories and at the plants of leading tube manufacturers. From this, a vital point stood out above all others which dictated that "the resultant tube tester design cannot be based upon just one selected characteristic, such as just mutual conductance alone."

☆ A tube test based upon just **any one characteristic** does not fully vouchsafe the overall performance capabilities of an amplifying tube.

When a vacuum tube is "receiver tested", the electronic circuits DEMAND PERFORMANCE predicated upon the simultaneous presence and interaction of a multiplicity of tube characteristics including the following:

- Electron Emission
- Amplification Factor
- Plate Resistance
- Mutual Conductance (Transconductance)
- Plate Current
- Power Output, etc.

☆ To perform a whole series of such individual tests, in order to evaluate the overall merit of a tube, involves a collection of laboratory equipment hardly available to the general user of vacuum tubes. In addition, these characteristics are very closely knit to operating parameters. To the electronically trained mind, this means that the predictable characteristic values are dependent upon the great variety of voltage, current and load conditions to which the tube, under consideration, may be subjected. This further means that for **ANY GIVEN TUBE TYPE, there is not just one value of mutual conductance or power output, etc. characteristic of that tube.**

For this very reason tube characteristic manuals list CURVES (graphs) of operation to assist the design engineer in selecting tubes and circuit parameters which he desires to employ in the particular receiver or other electronic apparatus being developed.

The printed tabular data listed in tube manufacturers' manuals is not to be considered as fixed and inflexible ratings. Rather, such examples of operating conditions are given merely as guiding information. The tubes can be and are used under any suitable conditions within their maximum ratings. The curves provide the information to determine the proper operating points which will yield a required characteristic.

☆ One other aspect of the tube engineering problem is the question of rejection limits for any particular characteristic. This actually is a double-barrelled topic. New tube production is concerned with "Production Tolerance Limits." The electronic design engineer, and of course the apparatus which uses the tubes, are further interested in "Life Test End Limits."

Electronic apparatus, using vacuum tubes, must not only perform well with tubes which are within "Production Tolerance Limits," but should be able to perform until the tube has reached its "Life Test End Limit."

Detailed specifications of such "limits" are not generally available to the field and of course, specific numerical characteristics tests (such as micromhos) are inconclusive unless compared to a detailed table of limits paralleling actual test parameters or actual testing conditions

Moreover, numerical characteristics readings (as micromhos) are not fully meaningful unless the tester duplicates the exact voltages and loads under which the particular tube in question is actually operating in the specific circuit from which it has been removed. It would furthermore require reference to the tube's plate family and transfer characteristic curves in order to determine what the numerical characteristic SHOULD be under the particular conditions in which the receiver is using this tube.

☆ Therefore, since the numerical value (such as micromhos) of a tube characteristic varies so widely with the applied element potentials, it is necessary to provide in TRUE vacuum tube characteristics measuring instruments.

1. Appropriate means for metering and reading each and every applied element potential.
2. Appropriate means for metering and reading each tube element current.
3. Suitable devices for adjustment and control of every element potential to duplicate operating conditions or to set up the specific operating point being investigated.

☆ It is obviously entirely impractical to construct such a device, for general tube testing, as would permit the operator to do this, not only from the viewpoint of simplicity of operation, but also in consideration of the extremely high cost and physical size.

Accordingly, such equipment (for actual numerical characteristics investigations) is only found in research and production laboratories, which are the only places wherein such elaborate equipment might ever be required.

Needless to say, it would also not be practical for a tube tester's chart data to offer a multiplicity of alternative test settings for each and every tube.

☆ It has therefore been the constant purpose of Precision engineers to develop a tube tester circuit which would best meet the realistic needs of the electronic maintenance and radio service professions; to develop a basic test circuit affording the ultimate in correlation between test results and actual "in application" performance.

In the course of such investigations, it becomes conclusively apparent, that regardless of amplifier tube type number or variety of circuit applications, one phenomenon constantly manifests itself; the tube output (voltage or power) is the result of a plate current caused by an applied control grid voltage, which current must be adequate even at full peak operating conditions. This being a basic concept of amplifier tube operation (involving all operating characteristics), it led to the now famous, time-proven and tried, Precision "Electronamic" (Reg'd U. S. Patent Office) tube tester.

☆ In offering the "Electronamic" tube tester, to the discriminating purchaser, Precision does so with a "performance checked" background. Such "performance" tests, particularly emphasized during World War II, were based upon the primary purpose of the instrument—TO FIND BAD TUBES!

☆ To familiarize ourselves with the principles of this "PRECISION" innovation, let us briefly observe the operation of a simple pentode such as the 2A5, in a standard power amplifier stage, shown in diagram A, with the addition of a current indicating meter in the plate circuit.

The primary purpose of this tube is to deliver electrical output to the speaker through plate load Z_p , in the following

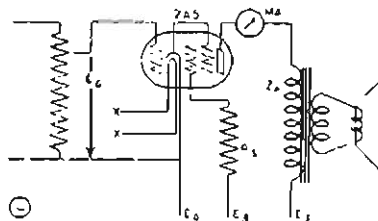

manner: with filament and plate supply operating and with zero signal applied to the input circuit, the plate milliammeter "MA" will indicate a steady current flow dependent upon cathode emissive power and the potentials of the interspaced elements. This zero signal meter reading is an indication of the tube's plate conductance. By applying an audio signal, Eg, to the input grid, THE PLATE CURRENT THROUGH Zp MUST VARY IN ACCORD WITH THE CHANGES IN GRID VOLTAGE. This is dependent upon the mutual conductance, plate resistance, amplification factor, load resistance, etc. The greater the grid voltage swing, the greater should be the plate current excursions, and accordingly, the louder the sound from the speaker.

Let us now assume that a high order of peak grid signal voltage is applied, that is in keeping with the tube operating conditions, but severe distortion is nevertheless produced at the speaker, even though all circuit components, aside from the tube, are normal. This condition coincides with low peak plate current readings, and is usually caused by poor cathode structure and/or high plate resistance. In other words, an insufficient quantity of electrons is available to the plate circuit to handle peak power requirements.

Now let us suppose that with a normal signal applied to the input circuit, insufficient or no volume is obtained from the speaker, again assuming all circuit components, aside from the tube, are normal. This condition would indicate that the magnitude of plate current variations versus applied grid signal are not in keeping with the tube specifications and circuit requirements. This can be caused by a multiplicity of internal tube conditions, including reduced amplification factor, low mutual conductance, open, misplaced or shorted screen, control grid, suppressor, or plate, even though the tube's cathode structure may be absolutely normal.

In the case of resistance-coupled amplifiers, the change in plate current produces a change in voltage drop across the plate load resistor. This is then passed on through suitable coupling means to the succeeding stage.

☆ It can therefore again be readily seen that the overall PERFORMANCE Merit of a tube is absolutely dependent on the ability of output plate current to respond to the applied grid voltage, over the full range of possible operating conditions, which involves More than just Mutual Conductance.

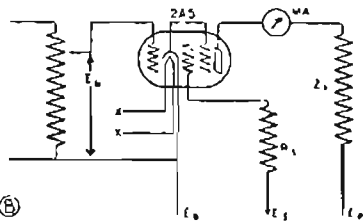

HIGH AS 300 VOLTS ARE APPLIED TO THE TUBES UNDER TEST DEPENDING ON THE INDIVIDUAL TUBE'S REQUIREMENTS.

Appropriate treatment is accorded all amplifier tubes depending whether they are triodes, tetrodes, etc. Multi-purpose tubes are treated and tested as two or more completely independent tubes, WITHOUT REMOVING THE TUBE FROM THE TEST SOCKET. All plate, screen, grid and filament test voltages and respective loads are factory calibrated (per the roller chart) to assure the high tube performance correlation for which the "Electronamic" tube testers are known to the field, both civilian and the military — a performance check based upon the peak service for which the tube was designed rather than just an arbitrarily chosen low or midpoint.

☆ As previously outlined, the overall quality or performance merit of a tube is dependent on how well control grid voltage "controls" plate current over a complete range of tube application.

For this reason, the PRECISION "Electronamic" circuit places the TUBE MERIT METER in the plate or output section only of the tubes under test. Accordingly, the resultant quality or performance figure of merit involves a whole series of meaningful operational factors, not just one inconclusive characteristic, and will reject all tubes which do not come up

to the same standards from which the tube chart data is prepared.

☆ Much of the success of the "Electronamic" tube tester is attributable to the ELECTRO-DYNAMIC SWEEP nature of its circuit operation. Through application of appropriately phased individual element potentials, the tube under test is dynamically swept over a Path of Operation, on a sinusoidal time base, encompassing a wide range of plate family characteristics curves. In brief, the tube under test is made to perform on a basis which involves its ability to operate at a multiplicity of

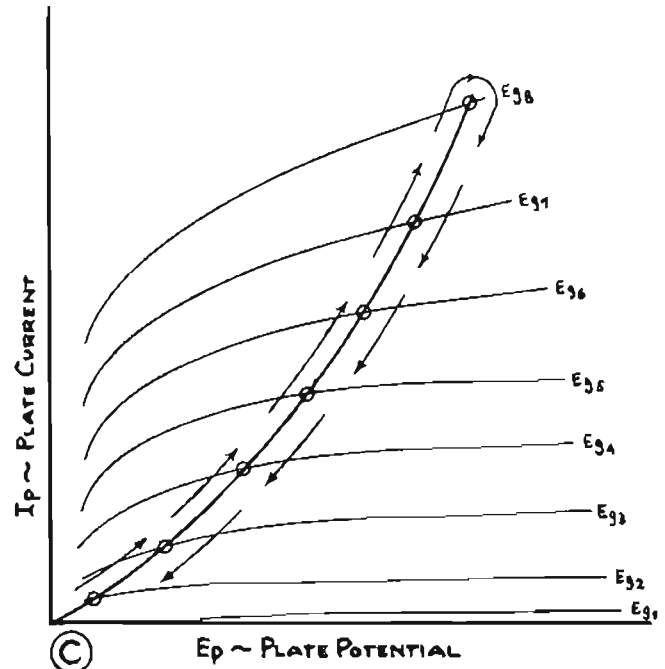

potential peak conditions rather than at just one arbitrarily chosen point.

Reference to diagram C graphically and directly illustrates this "Electronamic" picture. It is this encompassing Path of Operation, involving More than just Mutual Conductance, which is automatically integrated by the meter as the resultant figure of merit in the direct and non-confusing terms of REPLACE-WEAK-GOOD.

☆ The very nature of the "Electronamic" circuit necessitates and assures utmost instrument flexibility, to permit positive location and selection of all tube elements. In the "900" Series, this was accomplished via appropriate combination of a multi-purpose PUSH-BUTTON master element selector system plus simplified load-potential rotary switch design. In the "10-00" MASTER series, the "Electronamic" facilities are further magnified via design and use of a new LEVER TYPE master element selector system in combination with a multiple push-button short check unit, plus specially engineered rotary, load and element potential selectors.

☆ Aside from the development of the complete "Electronamic" circuit, full consideration was given to the design of a Hot Cathode Leakage test, inter-element Short Check, instantaneous Filament Continuity Test and Audible Noise Test, affording maximum reliability and accurate neon lamp indications to show up physical and mechanical tube defects such as cathode to filament leakage, shorted, loose or open elements, open filaments, etc. THE CATHODE LEAKAGE CIRCUIT SENSITIVITY IS ADJUSTED TO COMPLY WITH THE APPROVED LEAKAGE SPECIFICATIONS OF LEADING TUBE MANUFACTURERS. Additional independent circuit facilities appropriately accommodate all diodes, rectifiers, tuning eyes, gas rectifiers, thyatrons, etc.

☆ Modern methods of construction, telephone cabled wiring, Precision resistors and wire-wound impregnated shunts, and highest quality of materials combine, with INDIVIDUAL DUAL CALIBRATION against laboratory standards, insures maximum accuracy and ruggedness for lasting satisfaction. NEW TUBE TEST DATA CHARTS ARE FURNISHED UPON REQUEST FROM TIME TO TIME AT ABSOLUTELY NO CHARGE — FOR THE LIFE OF YOUR "PRECISION" TUBE CHECKER.

DECIBEL CHART

NEG.			POS.		NEG.			POS.	
Voltage Ratio	Power Ratio	-Db+	Voltage Ratio	Power Ratio	Voltage Ratio	Power Ratio	-DB+	Voltage Ratio	Power Ratio
1.0000	1.0000	0	1.000	1.000	.3162	.1000	10.0	3.162	10.000
.9772	.9550	.2	1.023	1.047	.3090	.09550	10.2	3.236	10.47
.9550	.9120	.4	1.047	1.096	.3020	.09120	10.4	3.311	10.96
.9333	.8710	.6	1.072	1.148	.2951	.08710	10.6	3.388	11.48
.9120	.8318	.8	1.096	1.202	.2884	.08318	10.8	3.467	12.02
.8913	.7943	1.0	1.122	1.259	.2818	.07943	11.0	3.548	12.59
.8710	.7586	1.2	1.148	1.318	.2754	.07586	11.2	3.631	13.18
.8511	.7244	1.4	1.175	1.380	.2692	.07244	11.4	3.715	13.80
.8318	.6918	1.6	1.202	1.445	.2630	.06918	11.6	3.802	14.45
.8128	.6607	1.8	1.230	1.514	.2570	.06607	11.8	3.890	15.14
.7943	.6310	2.0	1.259	1.585	.2512	.06310	12.0	3.981	15.85
.7762	.6026	2.2	1.288	1.660	.2455	.06026	12.2	4.074	16.60
.7586	.5754	2.4	1.318	1.738	.2399	.05754	12.4	4.169	17.38
.7413	.5495	2.6	1.349	1.820	.2344	.05495	12.6	4.266	18.20
.7244	.5248	2.8	1.380	1.905	.2291	.05248	12.8	4.365	19.05
.7079	.5012	3.0	1.413	1.995	.2239	.05012	13.0	4.467	19.95
.6918	.4786	3.2	1.445	2.089	.2188	.04786	13.2	4.571	20.89
.6761	.4571	3.4	1.479	2.188	.2138	.04571	13.4	4.677	21.88
.6607	.4365	3.6	1.514	2.291	.2089	.04365	13.6	4.786	22.91
.6457	.4169	3.8	1.549	2.399	.2042	.04169	13.8	4.898	23.99
.6310	.3981	4.0	1.585	2.512	.1995	.03981	14.0	5.012	25.12
.6166	.3802	4.2	1.622	2.630	.1950	.03802	14.2	5.129	26.30
.6026	.3631	4.4	1.660	2.754	.1905	.03631	14.4	5.248	27.54
.5888	.3467	4.6	1.698	2.884	.1862	.03467	14.6	5.370	28.84
.5754	.3311	4.8	1.738	3.020	.1820	.03311	14.8	5.495	30.20
.5623	.3162	5.0	1.778	3.162	.1778	.03162	15.0	5.623	31.62
.5495	.3020	5.2	1.820	3.311	.1738	.03020	15.2	5.754	33.11
.5370	.2884	5.4	1.862	3.467	.1698	.02884	15.4	5.888	34.67
.5248	.2754	5.6	1.905	3.631	.1660	.02754	15.6	6.026	36.31
.5129	.2630	5.8	1.950	3.802	.1622	.02630	15.8	6.166	38.02
.5012	.2512	6.0	1.995	3.981	.1585	.02512	16.0	6.310	39.81
.4898	.2399	6.2	2.042	4.169	.1549	.02399	16.2	6.457	41.69
.4786	.2291	6.4	2.089	4.365	.1514	.02291	16.4	6.607	43.65
.4677	.2188	6.6	2.138	4.571	.1479	.02188	16.6	6.761	45.71
.4571	.2089	6.8	2.188	4.786	.1445	.02089	16.8	6.918	47.86
.4467	.1995	7.0	2.239	5.012	.1413	.01995	17.0	7.079	50.12
.4365	.1905	7.2	2.291	5.248	.1380	.01905	17.2	7.244	52.48
.4266	.1820	7.4	2.344	5.495	.1349	.01820	17.4	7.413	54.95
.4169	.1738	7.6	2.399	5.754	.1318	.01738	17.6	7.586	57.54
.4074	.1660	7.8	2.455	6.026	.1288	.01660	17.8	7.762	60.26
.3981	.1585	8.0	2.512	6.310	.1259	.01585	18.0	7.943	63.10
.3890	.1514	8.2	2.570	6.607	.1230	.01514	18.2	8.128	66.07
.3802	.1445	8.4	2.630	6.918	.1202	.01445	18.4	8.318	69.18
.3715	.1380	8.6	2.692	7.244	.1175	.01380	18.6	8.511	72.44
.3631	.1318	8.8	2.754	7.586	.1148	.01318	18.8	8.710	75.86
.3548	.1259	9.0	2.818	7.943	.1122	.01259	19.0	8.913	79.43
.3467	.1202	9.2	2.884	8.318	.1096	.01202	19.2	9.120	83.18
.3388	.1148	9.4	2.951	8.710	.1072	.01148	19.4	9.333	87.10
.3311	.1096	9.6	3.020	9.120	.1047	.01096	19.6	9.550	91.20
.3236	.1047	9.8	3.090	9.550	.1023	.01047	19.8	9.772	95.50
					.1000	.01000	20.0	10.000	100.00

VOLTAGE RATIOS BEYOND THE RANGE OF THE TABLES.

A. Ratios less than those in tables: Multiply ratio by 10 successively until the result can be found in the tables. From the decibel value found from the table subtract +20Db for each time the multiple of 10 was used.

Example: - Voltage Ratio of 0.02042 - find Db value: -
 $0.02042 \times 10 \times 10 = 2.042$ from the table: - Voltage ratio of 2.042 = 6.2 Db
 6.2 Db - 20 Db - 20 Db = -33.8 Db.

B. Ratios greater than those in tables: Divide ratio by 10 successively until the result can be found in the tables. To the Db value found from the table add +20Db for each time the divisor of 10 was used.

Example: - Voltage Ratio of 407.4 - find Db value: -
 $407.4 \div 10 \div 10 = 4.074$ from the table: - Voltage ratio of 4.074 = 12.2 Db
 12.2 Db + 20 Db + 20 Db = 52.2 Db.

PRECISION APPARATUS COMPANY, INC.

92-27 HORACE HARDING BLVD. • ELMHURST, NEW YORK